

**MULD
KING**®

宇宙军事系列
MILITARY

虎式坦克
NO. TIGER TANK

宇宙霸王

20014



OPEN

Customer Service
客户服务

 www.yx-mk.com



酷砖家
BriXpert

酷砖家系列是宇星设立的全新子品牌/系列。本系列所有套装均由国内外顶级设计师操刀设计或授权,旨在为消费者带来高水准的积木设计套装和与众不同的拼搭体验。

BriXpert series is a new sub-brand/series set up by Meold King. Models of this series are all designed or authorized by top designers/MOCers around the world, aiming at bringing consumers with high-level brick sets and a unique building experience.

广东宇星科技

微信扫描二维码, 关注公众号。
获取第一手的新品资讯, 享受
便捷的补件服务。



Qr code APP (APP二维码)

Need the apple version 9.0
and above, the android
version 5.0 and above.

***The QR code is generated by the third-party application on the mobile device with a scanner. © Anxin Research, All rights reserved. For more information, please contact us at service@yx-mk.com.





虎I坦克是第二次世界大战中德意志国防军所使用的的坦克。正式名称为六号坦克。一般称为虎式坦克，简称“虎式”。从1942年下半年服役起至1945年，一直是活跃于第一线的重型坦克。

The Tiger I tank was a tank used by the Wehrmacht during World War II. The official name is Tank VI. Generally known as the Tiger Tank, referred to as "Tiger". Service from the second half of 1942 to 1945, it has been active in the front line of heavy tanks.

虎式坦克的车体前方装甲厚度为100毫米，铸造炮塔前方为120毫米，侧面与后方的装甲为80毫米，侧面下方为60毫米，而上方与底部的装甲为25毫米。后来炮塔上的天盖装甲增加至40毫米。由地板到炮塔天井的高度为157厘米。炮塔环的直径为1,850毫米。炮塔的侧面设有逃脱用的舱盖。舱盖的厚度为80毫米。

The Tiger's front hull armor is 100mm thick, 120mm in front of the cast turret, 80mm on the sides and rear, 60mm under the sides, and 25mm on the top and bottom. Later the canopy armor on the turret was increased to 40 mm.. The height from the floor to the turret patio is 157 cm. The diameter of the turret ring is 1,850 mm. The sides of the turret were provided with escape hatches. The thickness of this hatch is 80 mm.

虎式坦克采用的主炮跑尾及点火结构为德军88毫米高射炮。弹道低伸笔直，配备蔡司TFZ9b瞄准器。

The main gun tail and ignition structure used by the Tiger tank is the German 88mm anti-aircraft gun. The trajectory is low and straight, and it is equipped with a Zeiss TFZ8b sight.

虎式坦克在1942年8月开始生产，直到1944年8月停产为止共生产了1355辆。1944年7月拥有最大数量为671辆。

Production of the Tiger tank began in August 1942, and a total of 1,355 units were produced until production ceased in August 1944. In July 1944, the maximum number was 671 vehicles.

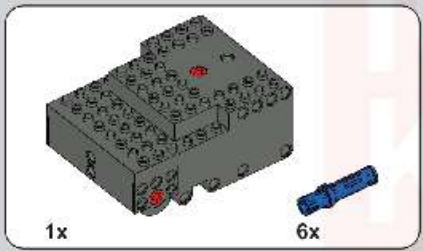
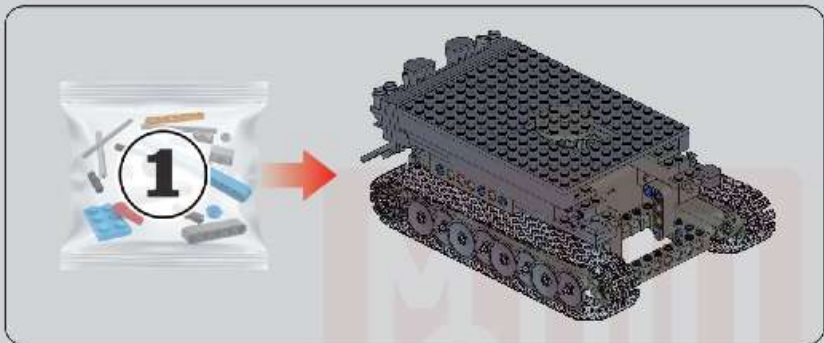

1

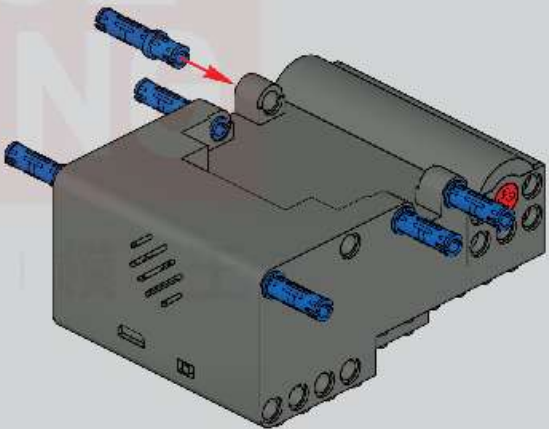

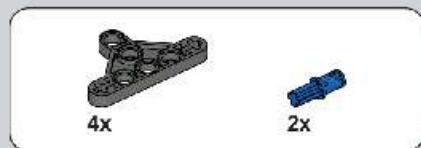

2

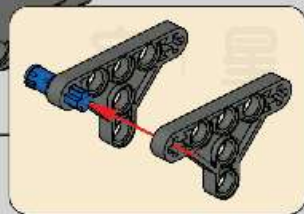
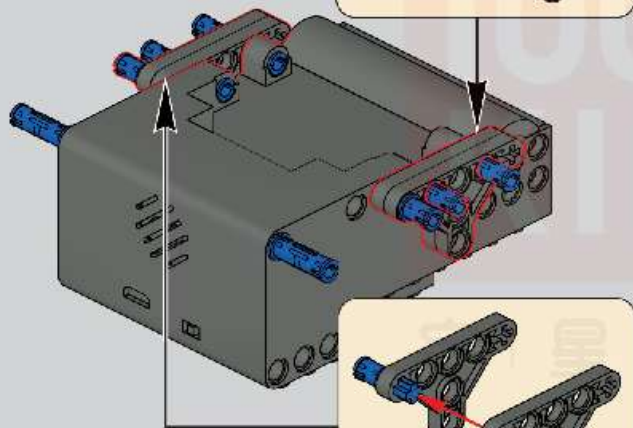
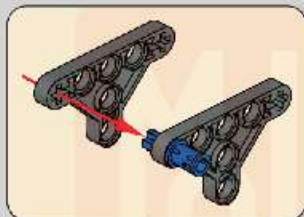

2



3

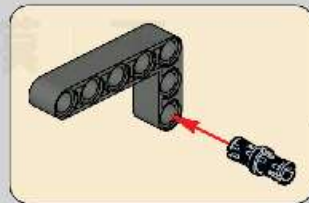
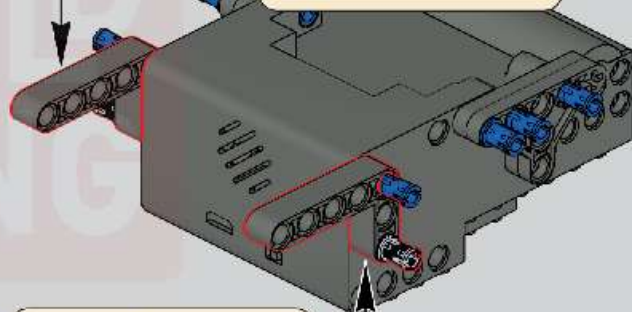
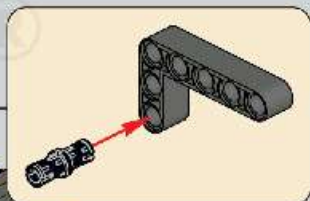

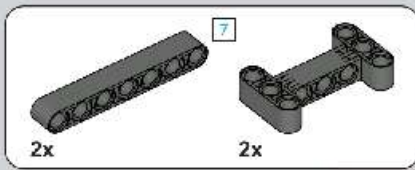

4

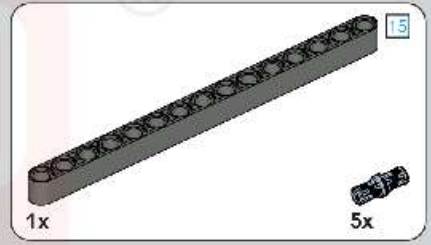
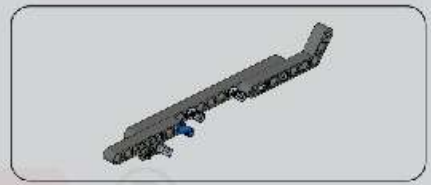
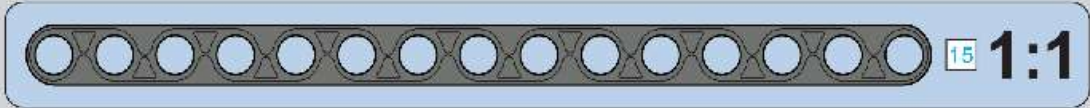
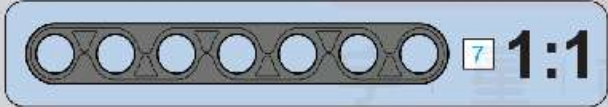
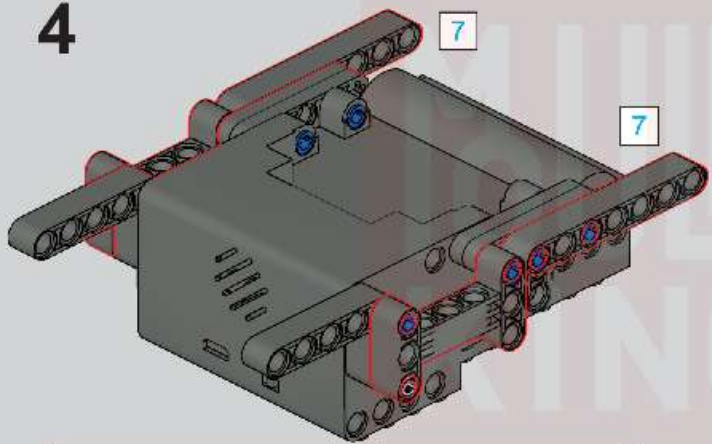

5

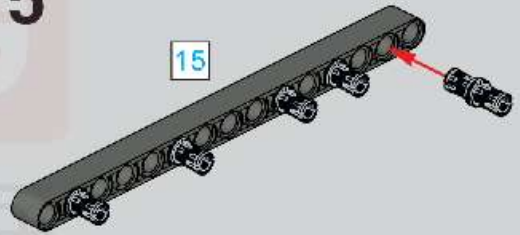

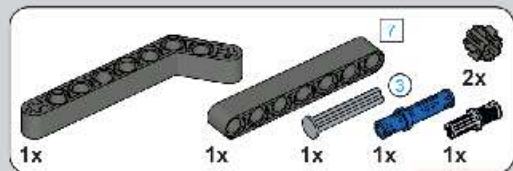

6

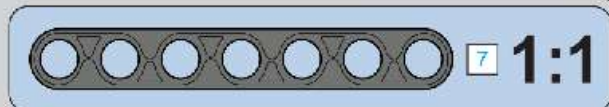
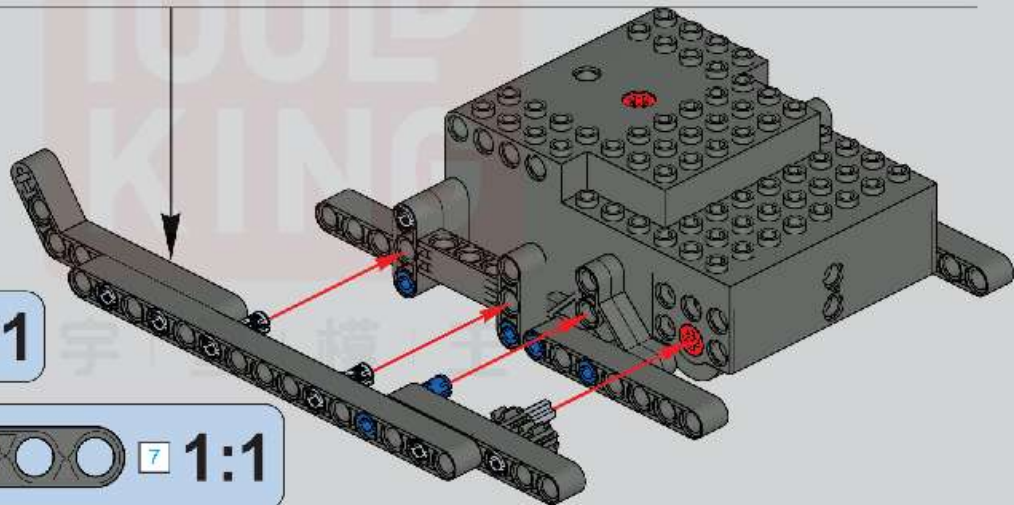
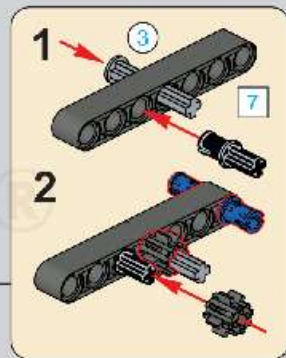
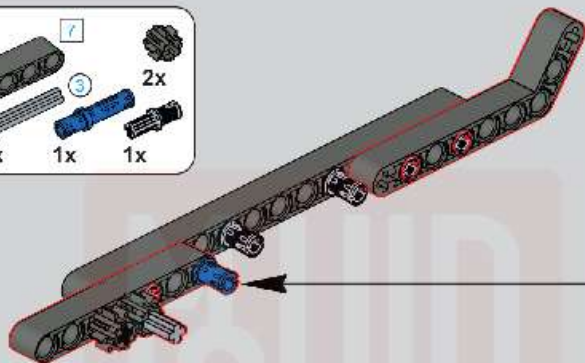

4

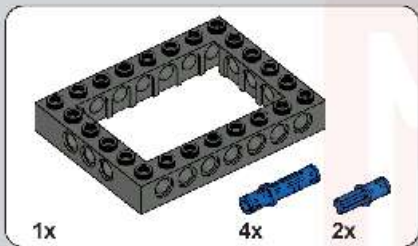
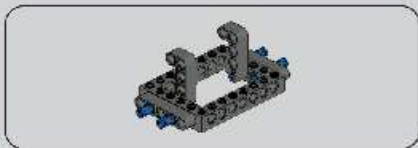

7

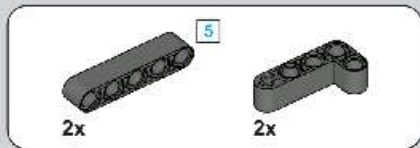
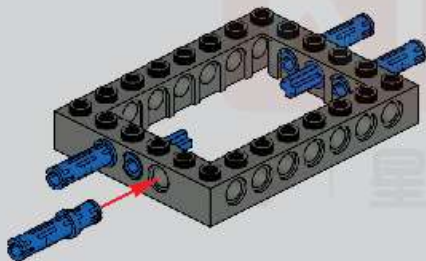

8

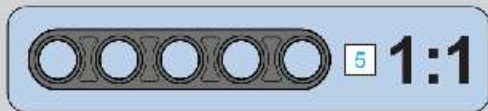
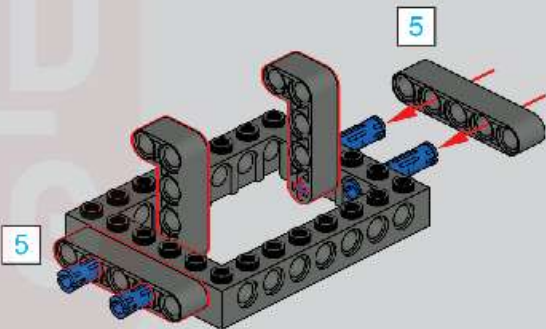

9

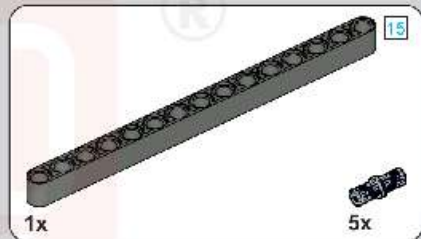
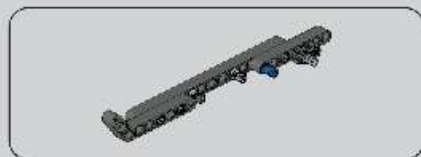
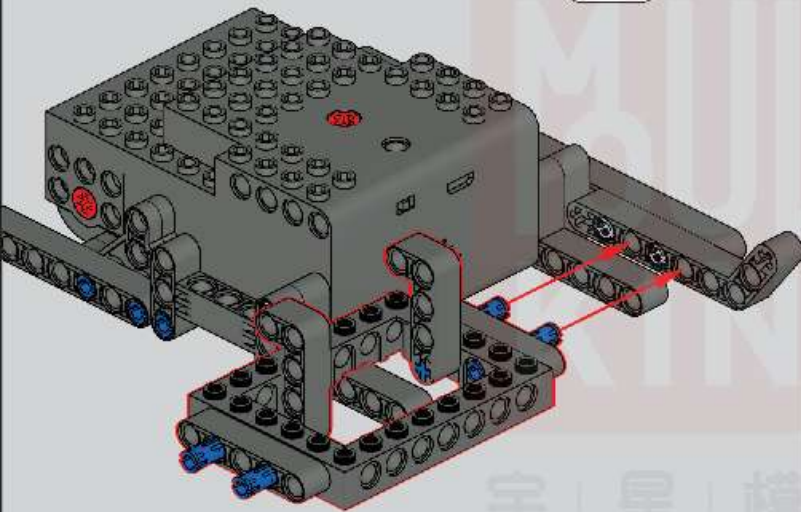

10

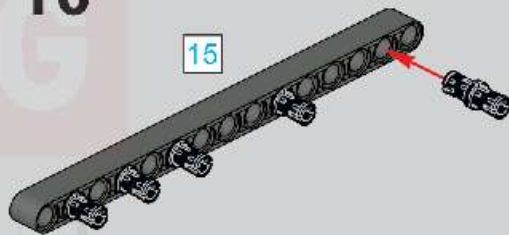

6

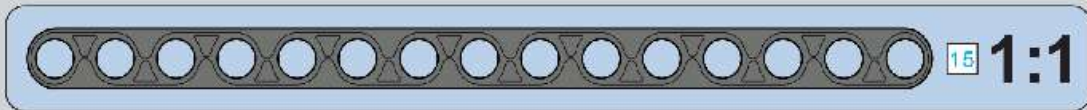

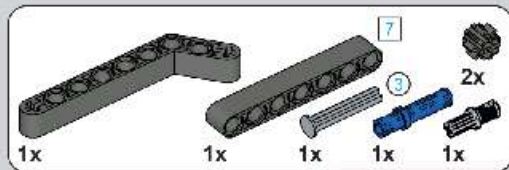

11

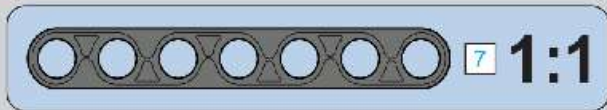
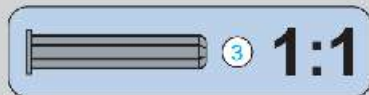
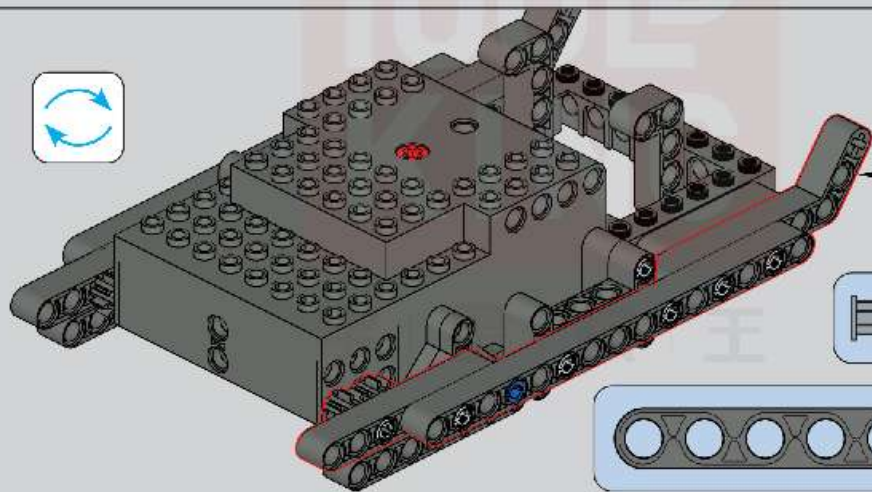
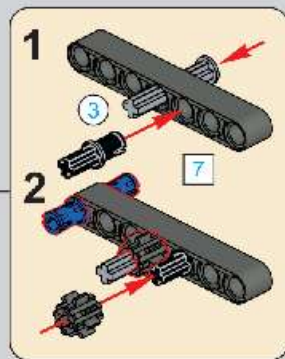
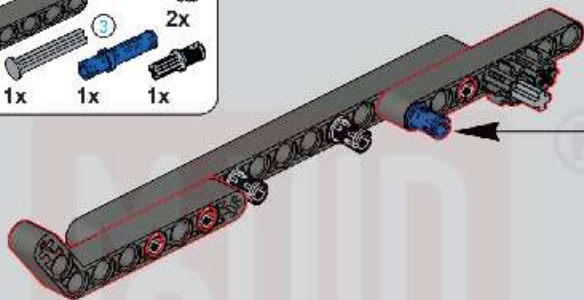

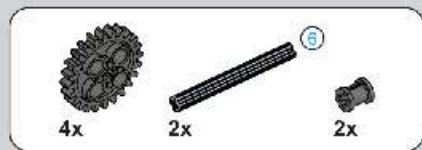

12

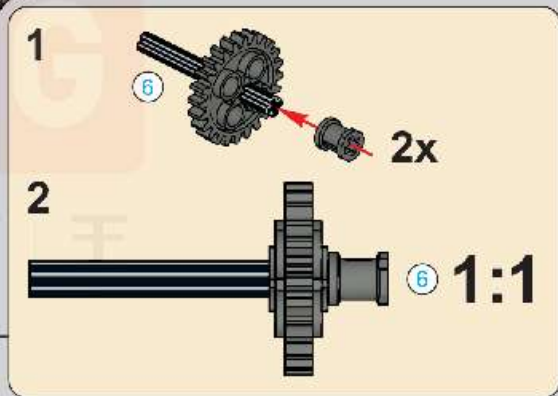
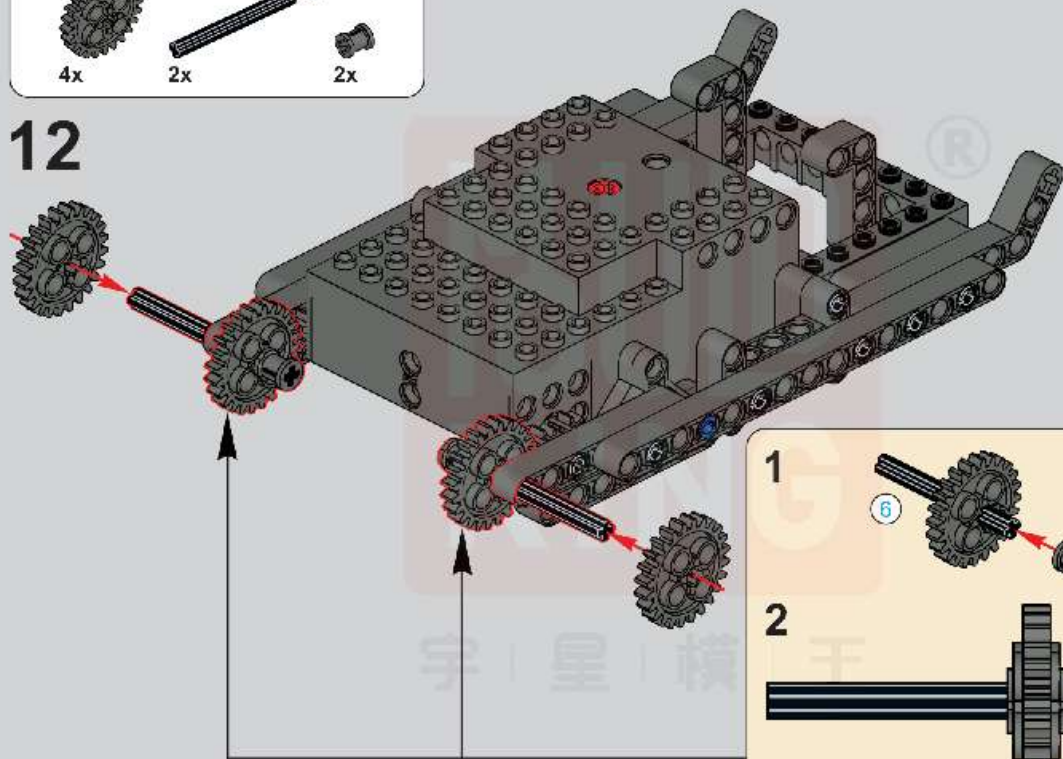



1x



9x

13

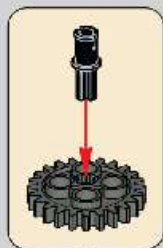
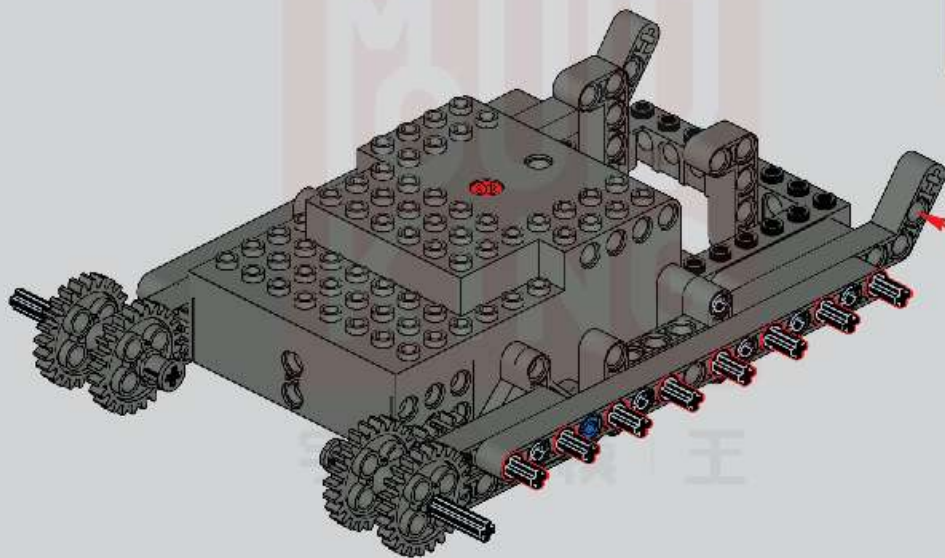



14

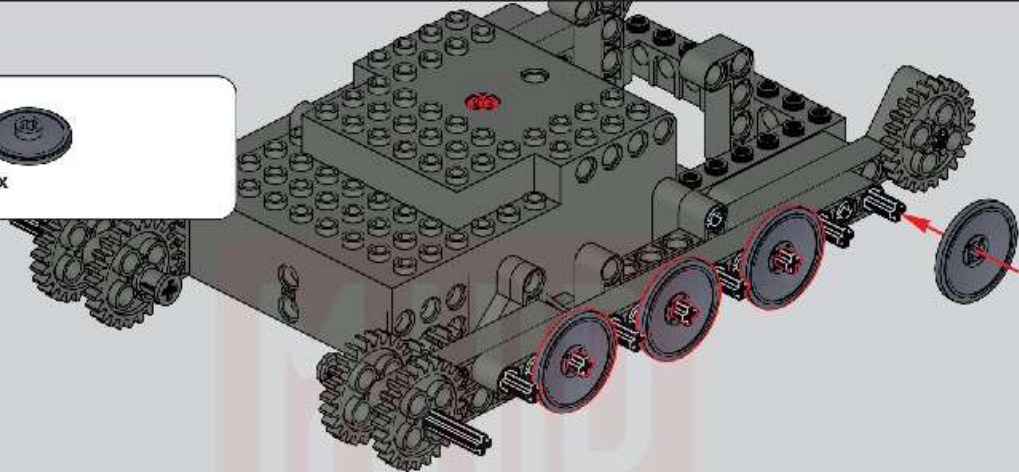

15

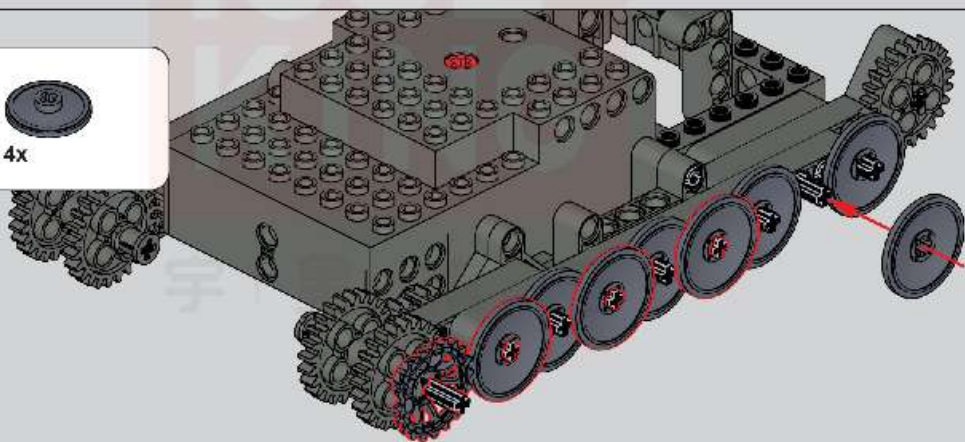



1x



9x

16

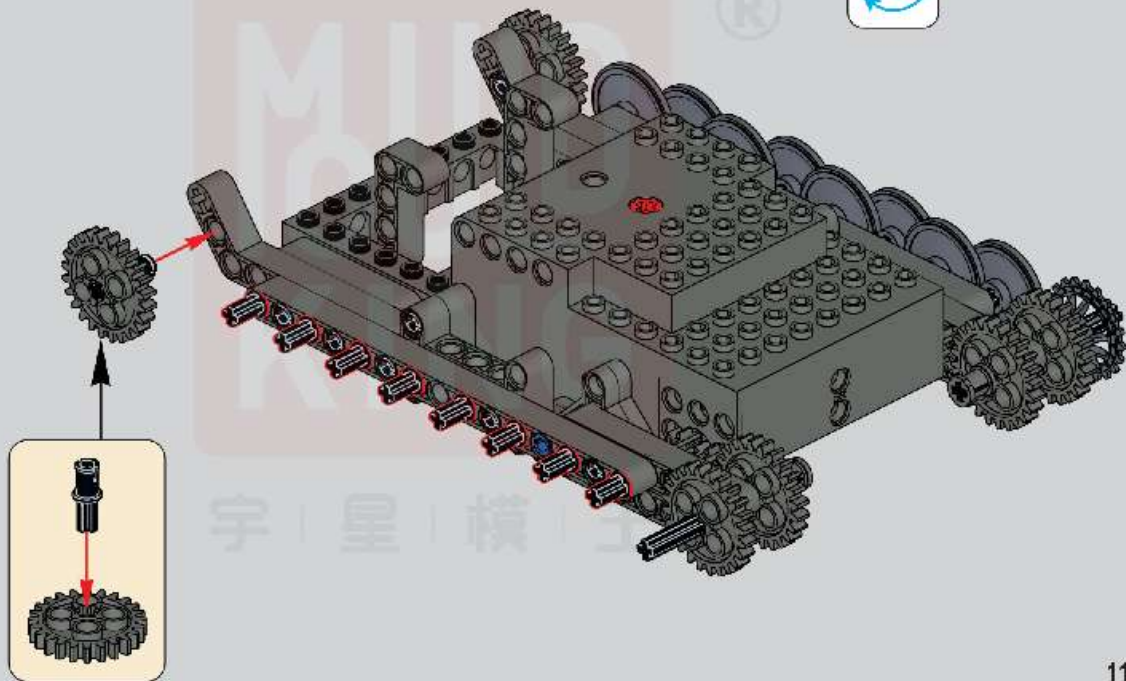



17

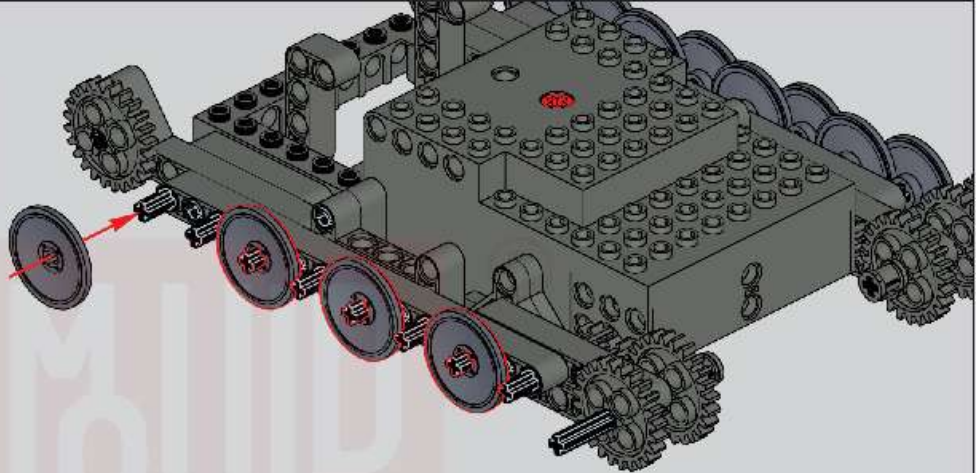

18

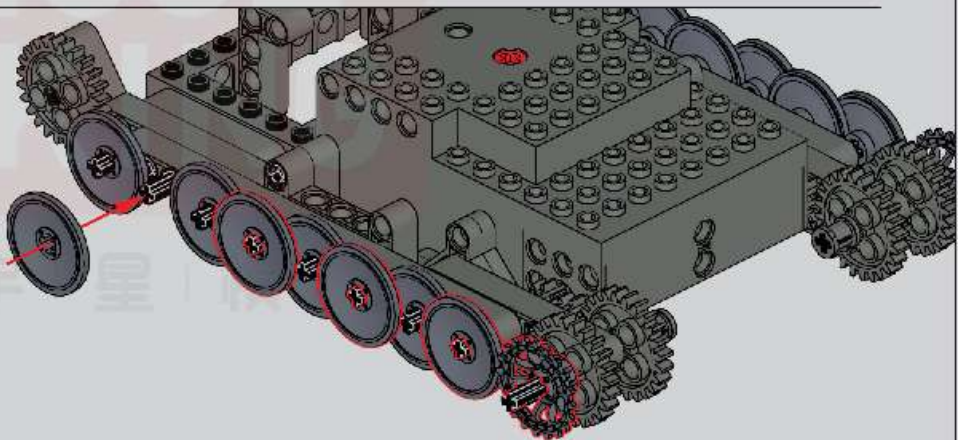



122x

19

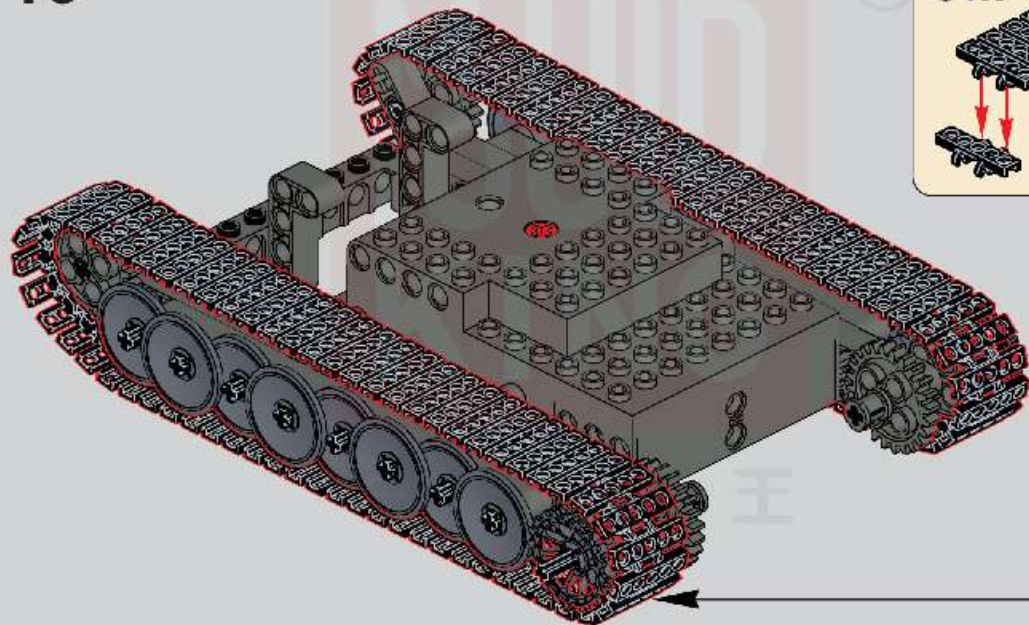

61x

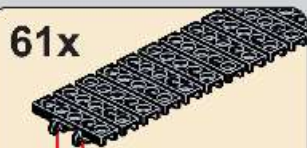

2x

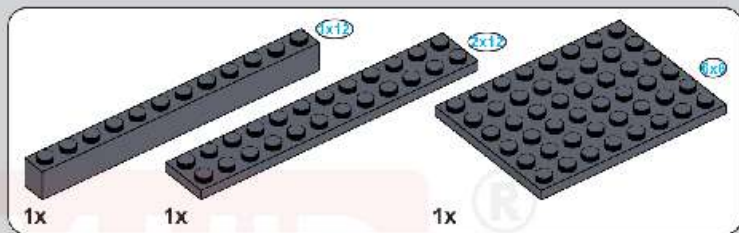
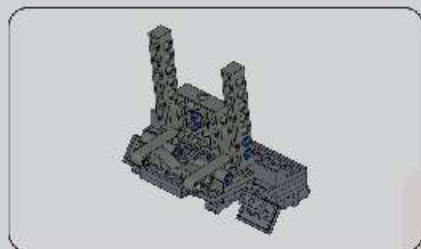

20

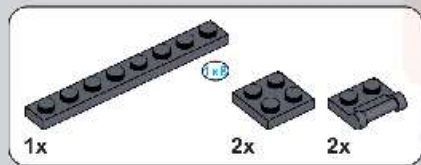
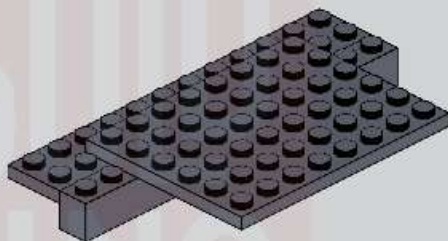

21

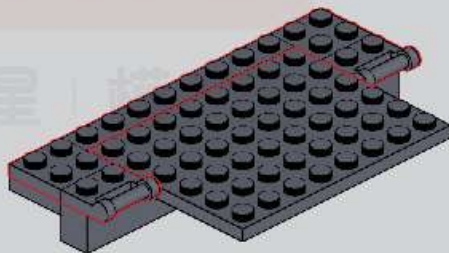

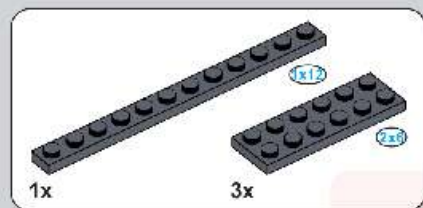

22

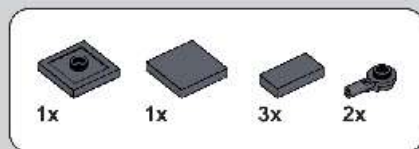
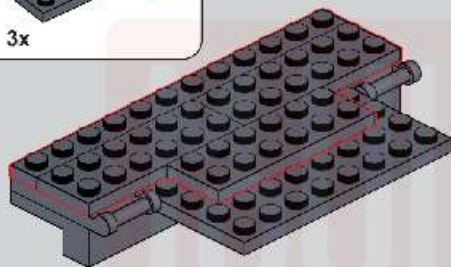

23

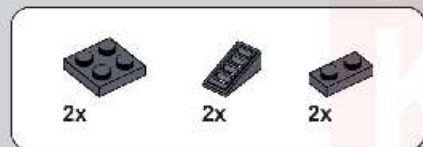
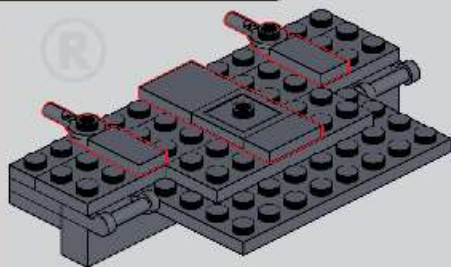

24

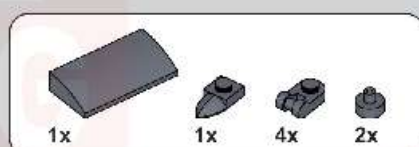
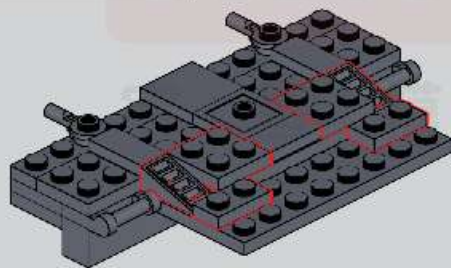

25

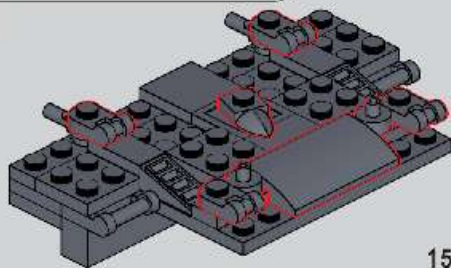



26

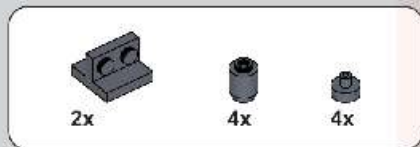
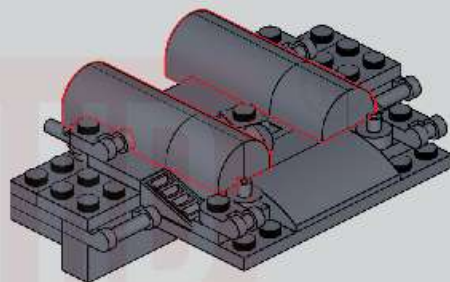

27

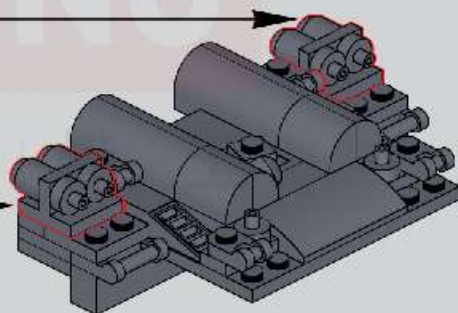
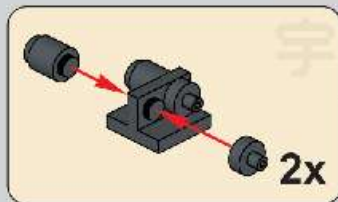



2x



2x



2x

28

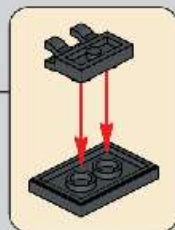
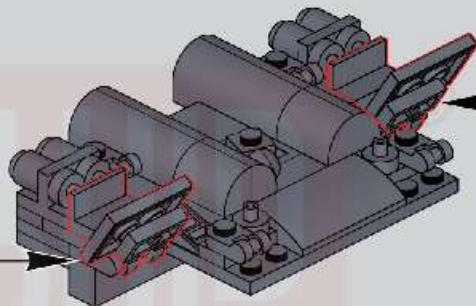
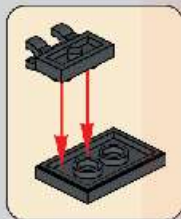

1x



2x

29

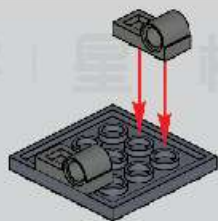

30



2x



2x

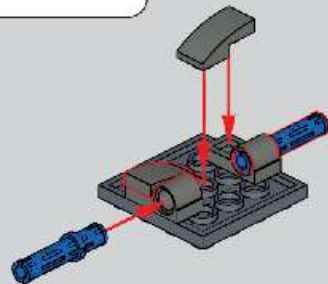

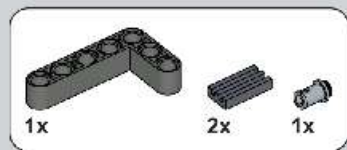

31

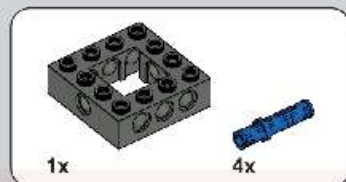
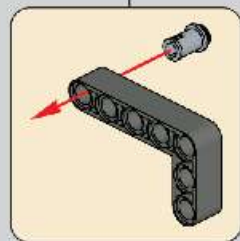
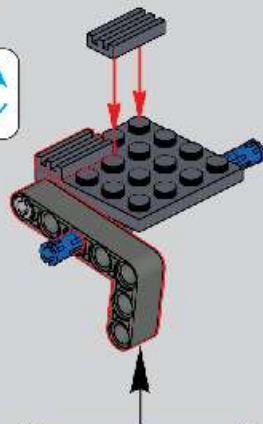

32

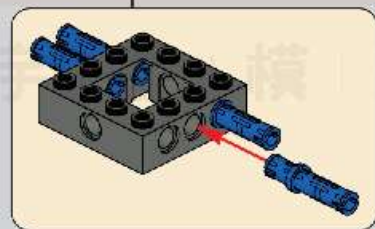
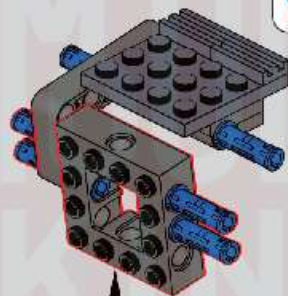

33

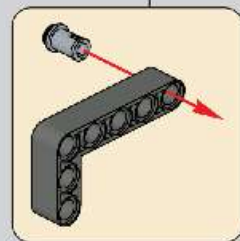
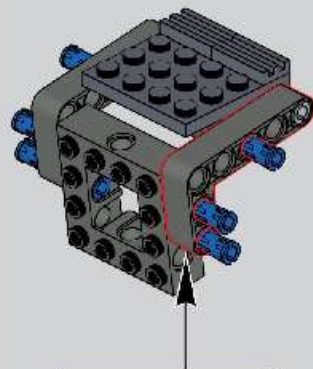



2x



2x

34

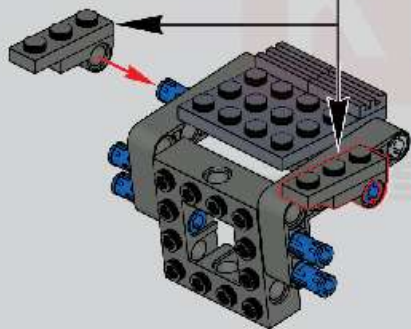
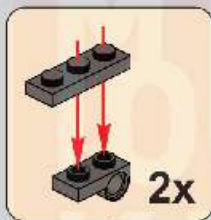

2x

35

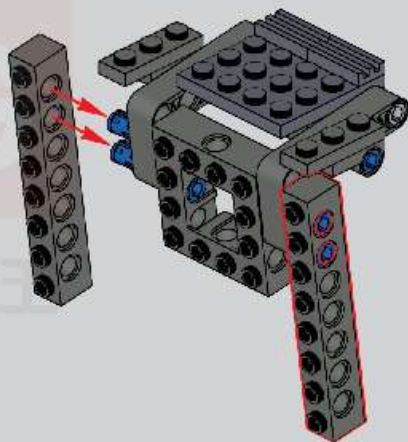

36

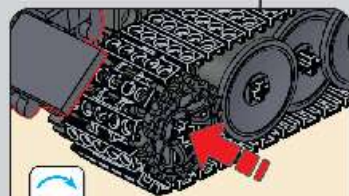
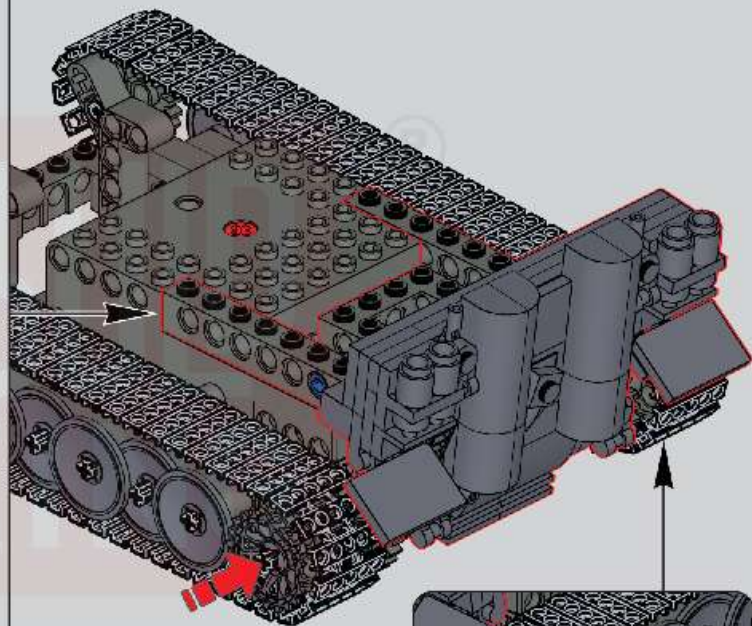
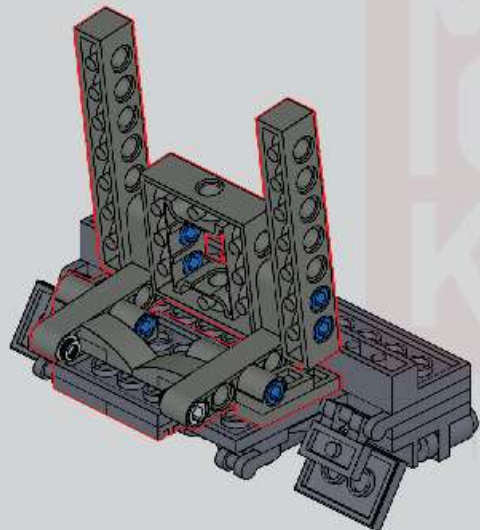

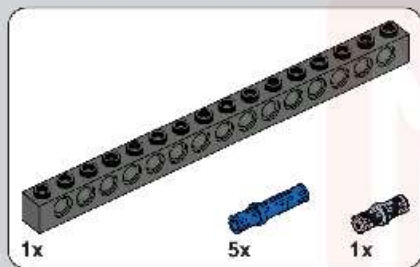
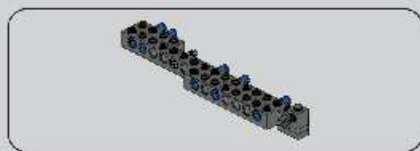

37

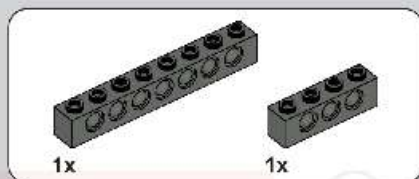
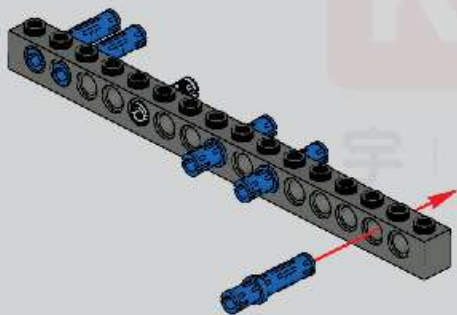

38



39

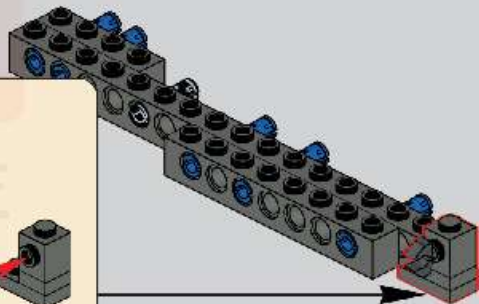
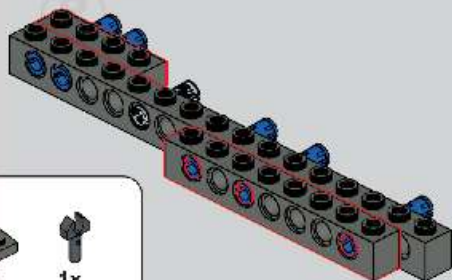
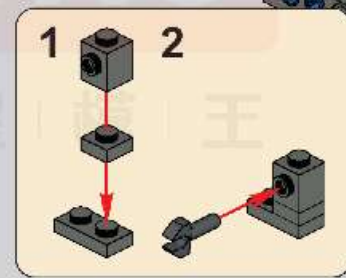

40

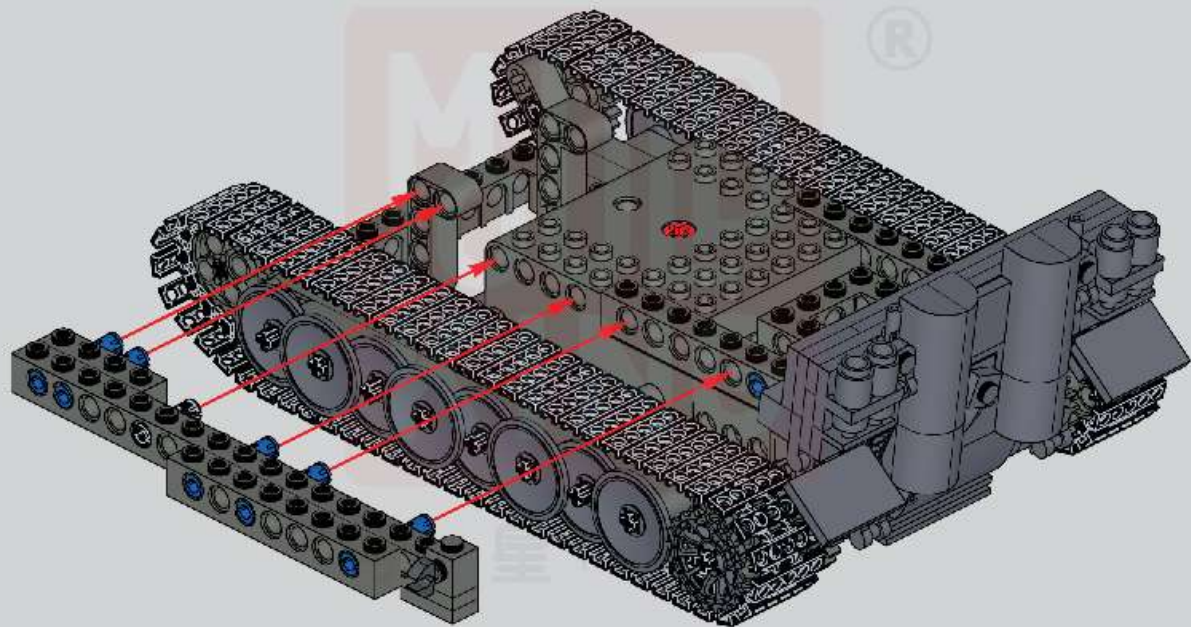

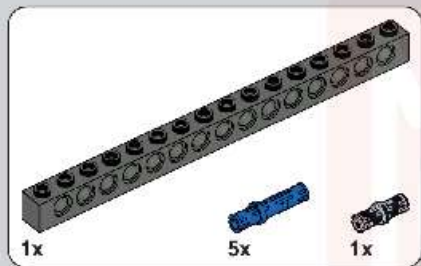
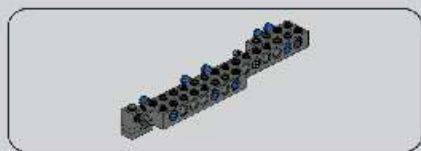

41

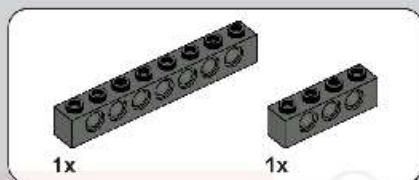
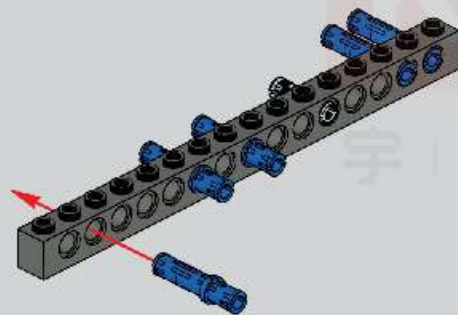

42

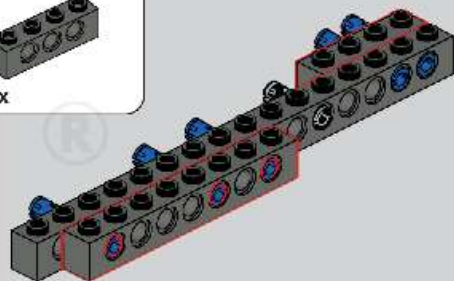

43

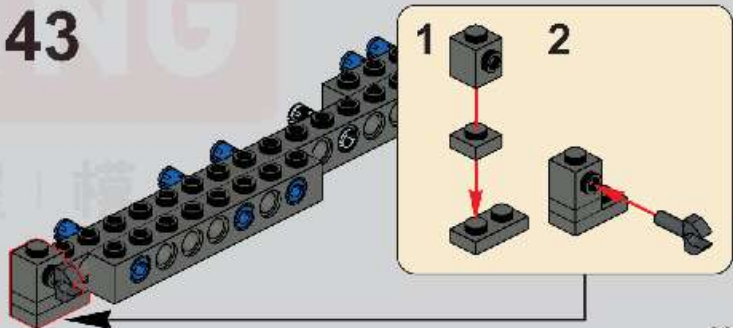

44

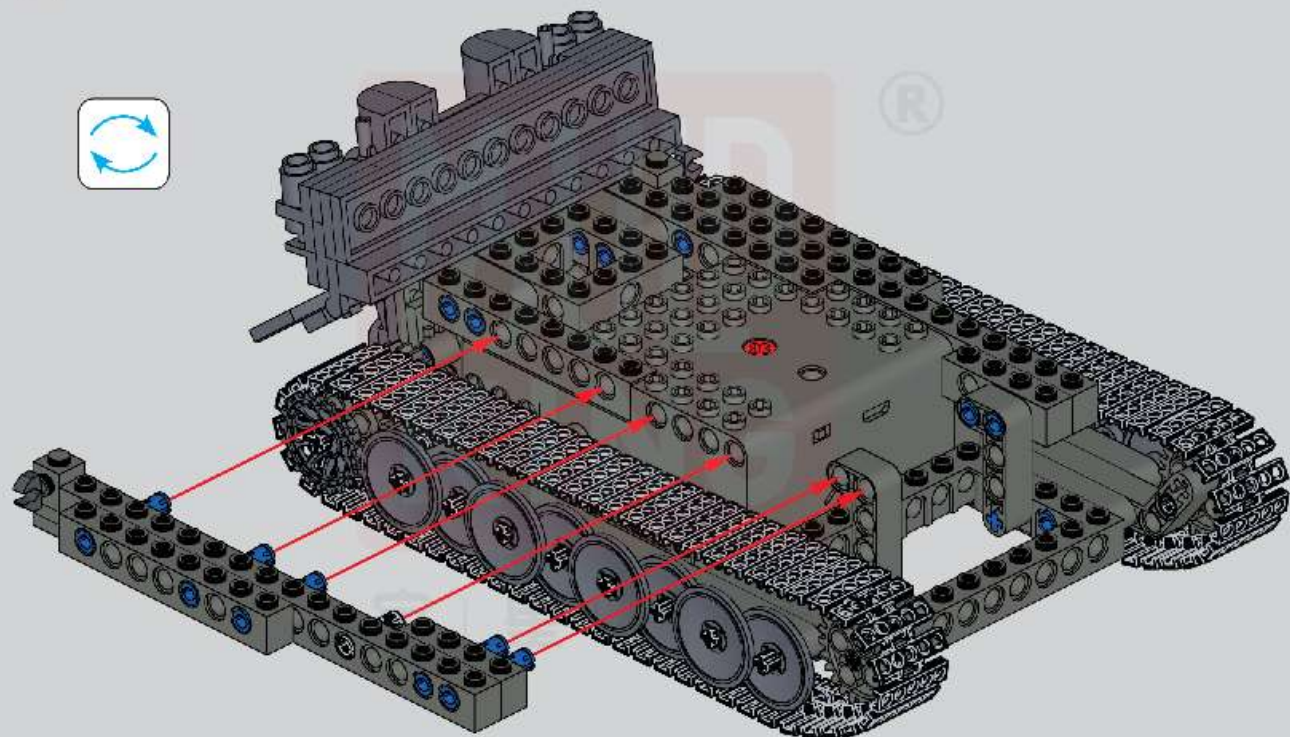

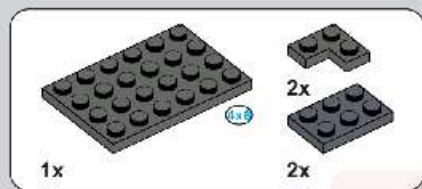

45

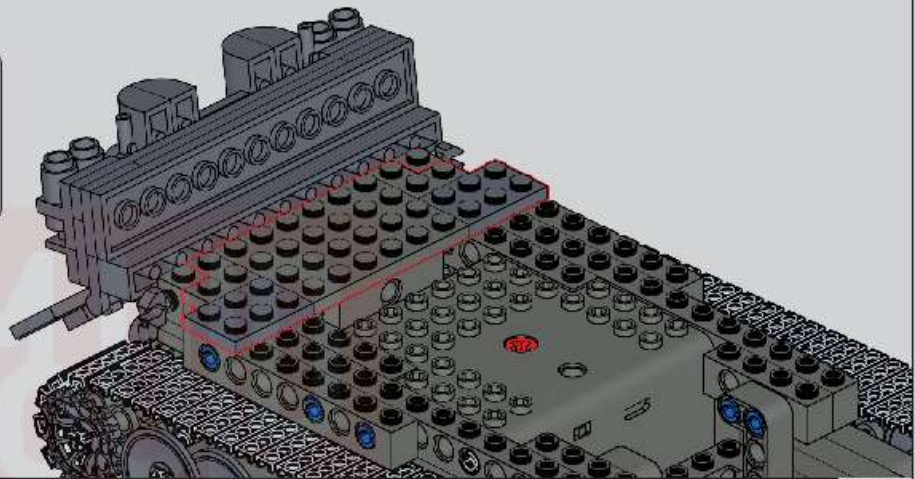

46

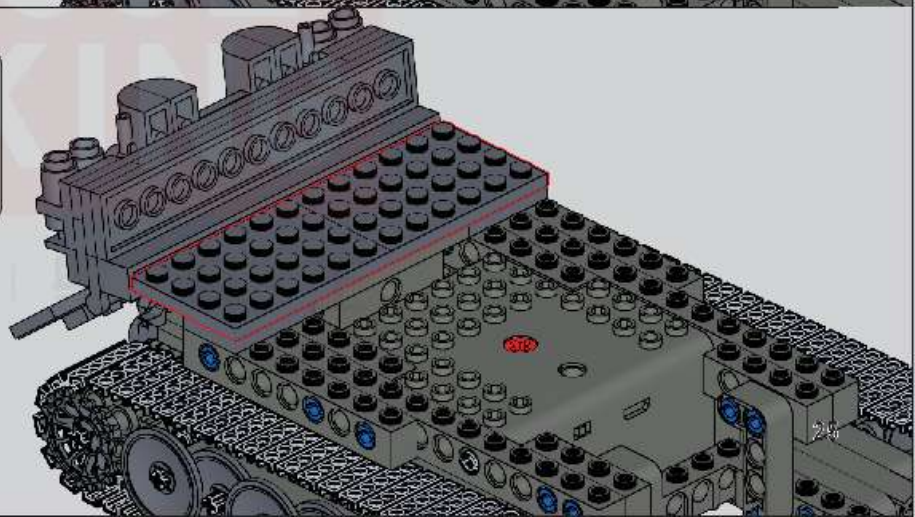

47

4x

2x

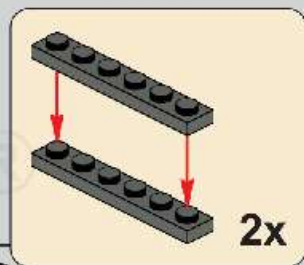
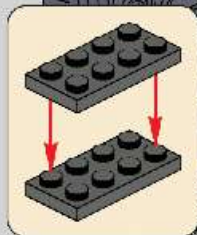

2x

48

1x

2x

4

2x

1x

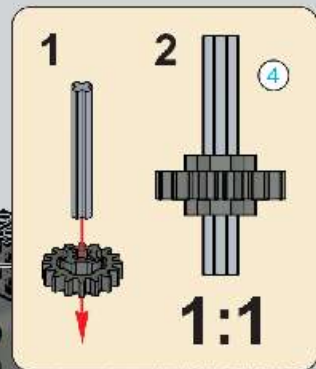
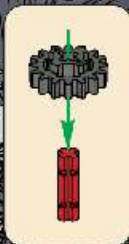

1

2

4

1:1

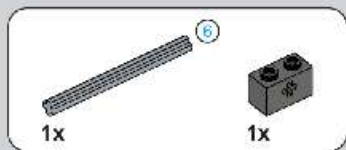
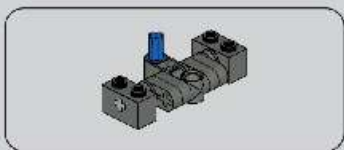

49

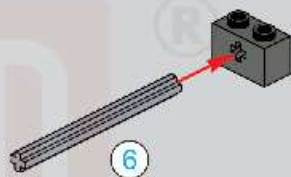

50

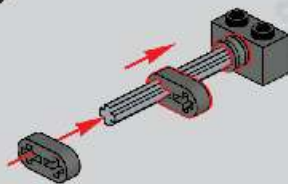

51

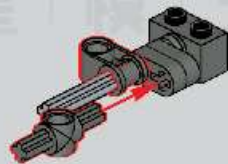

52

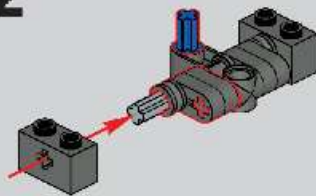

53

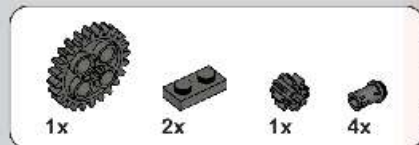
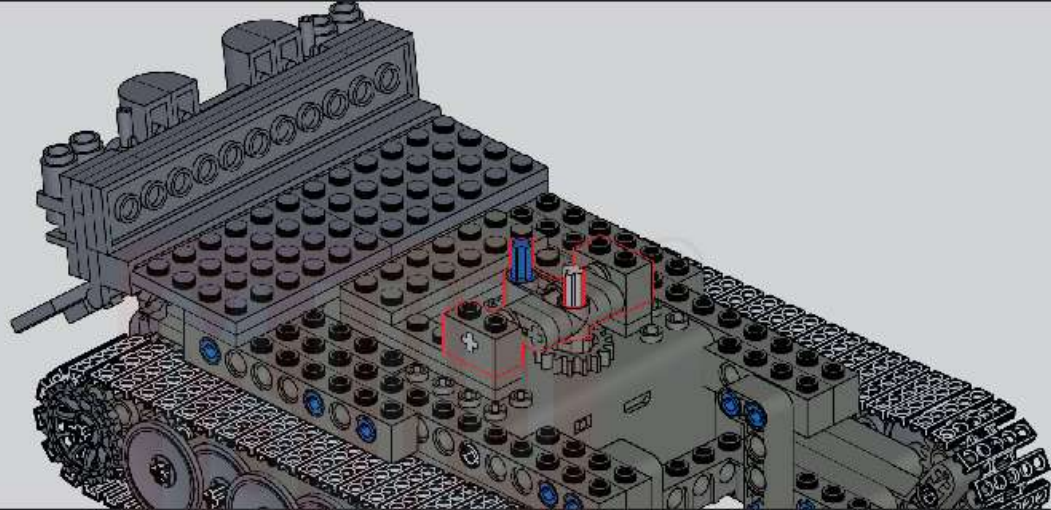

54

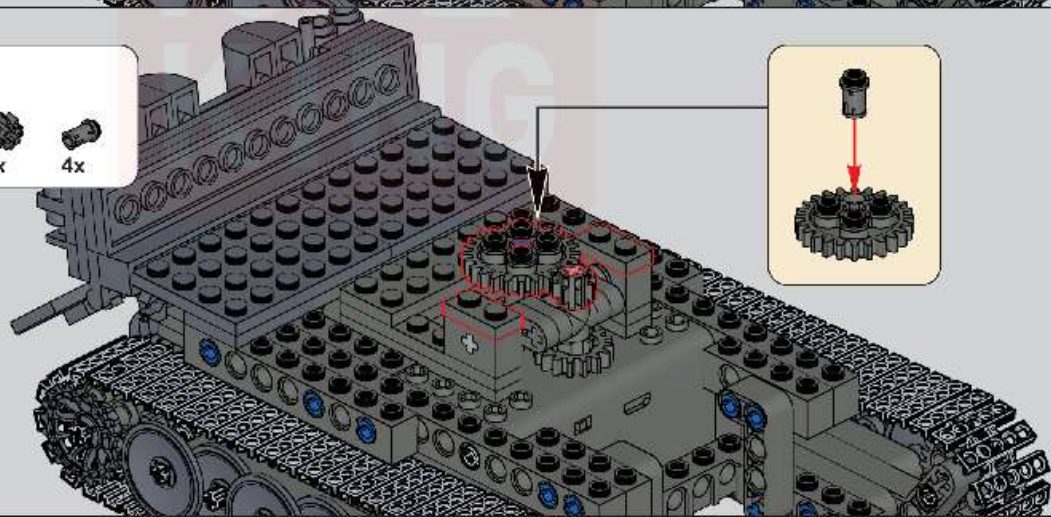



1x

55

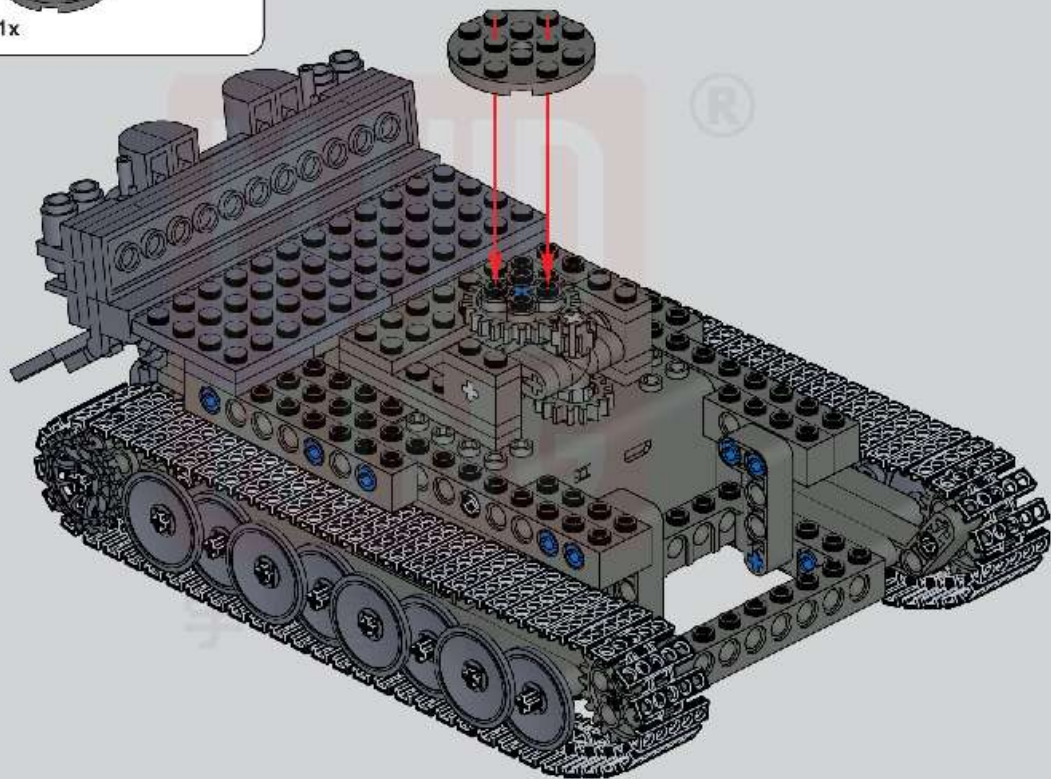

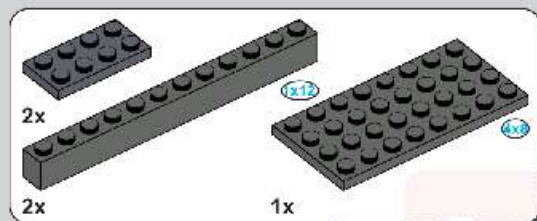

56

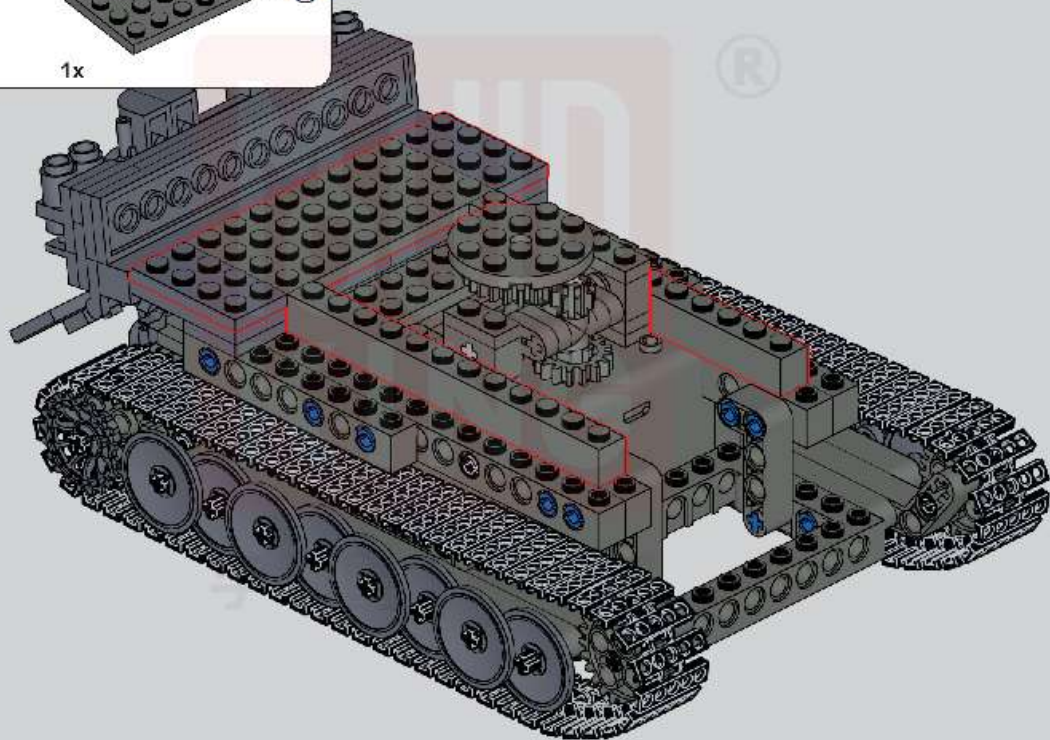

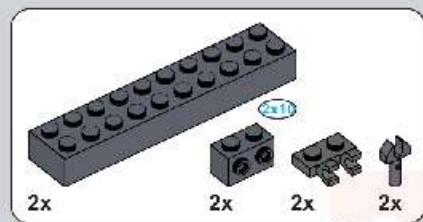

57

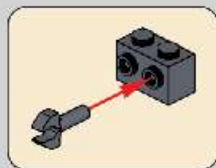
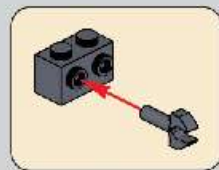
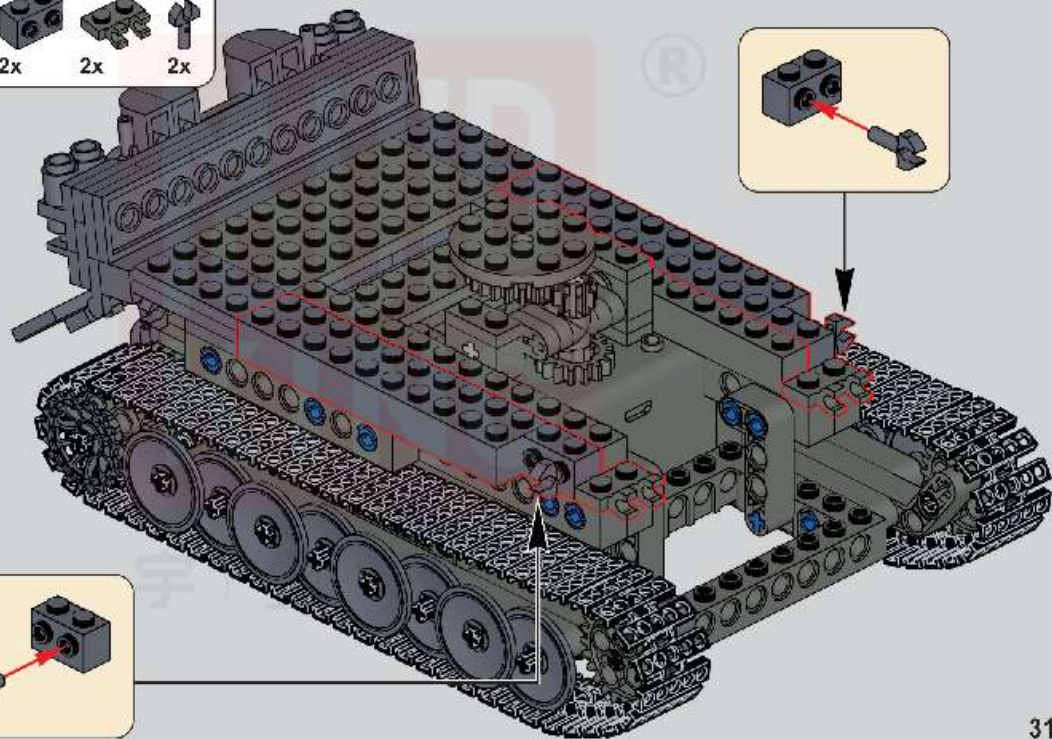

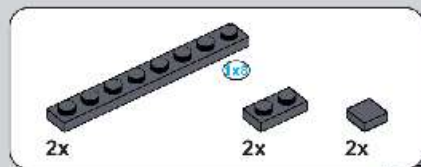

58

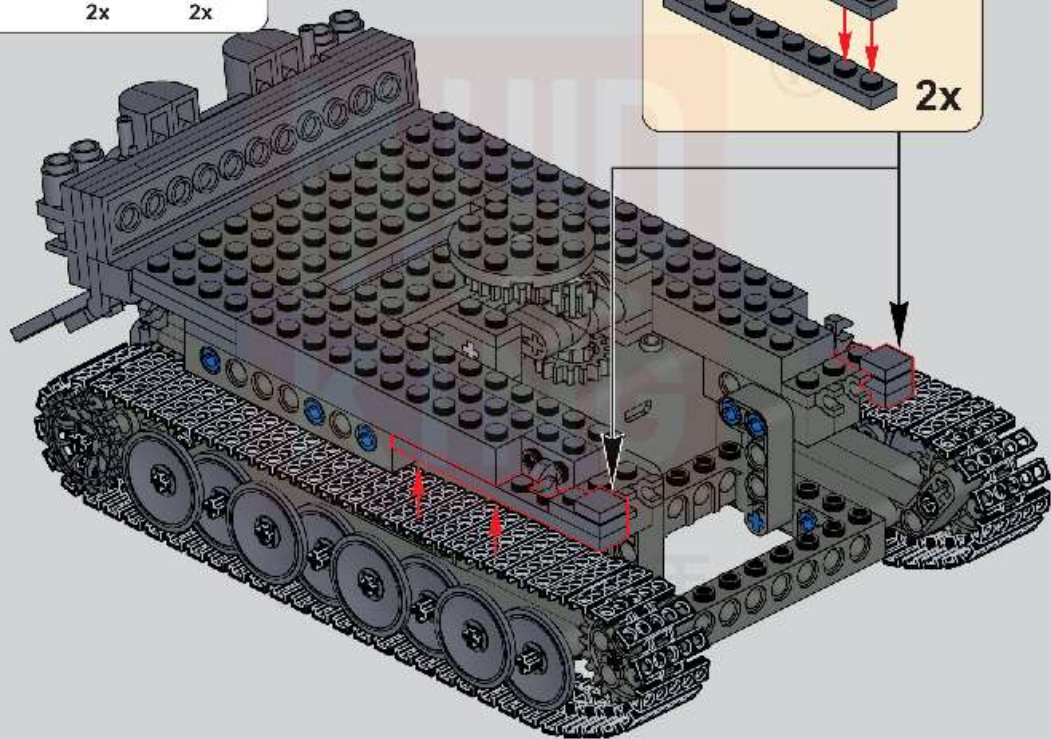
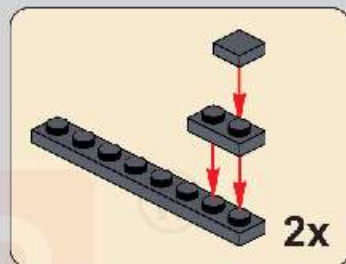

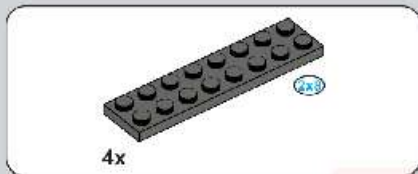

59

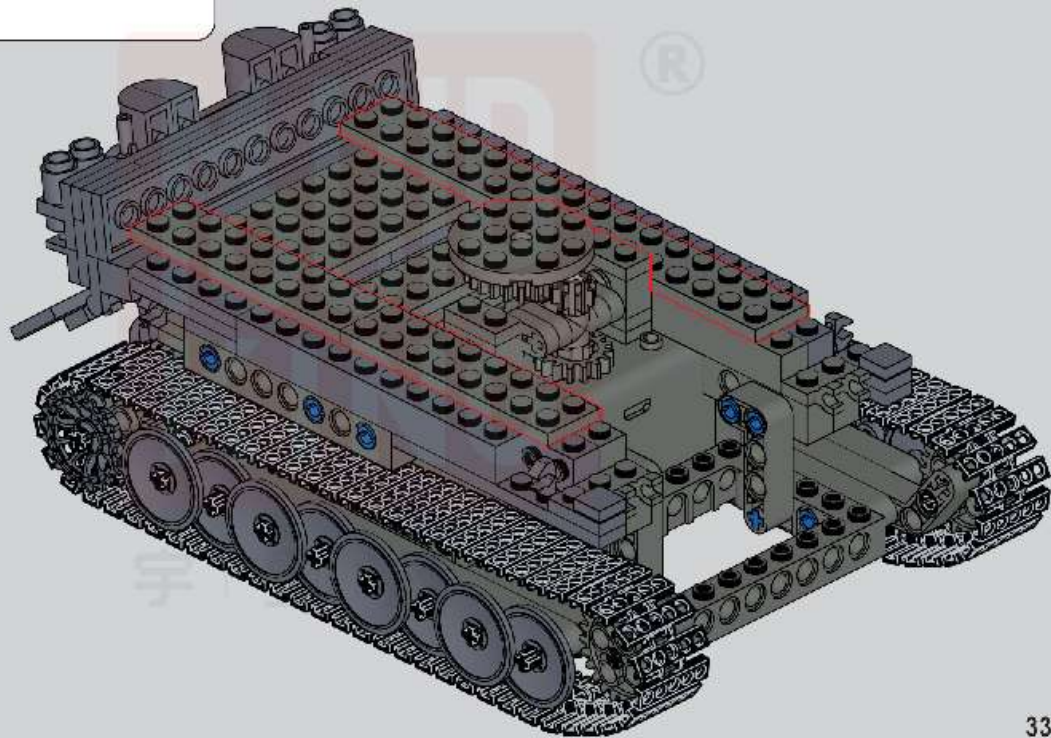

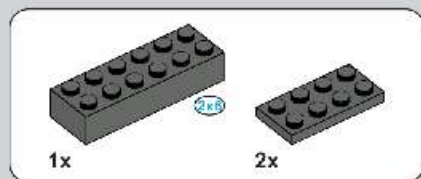

60

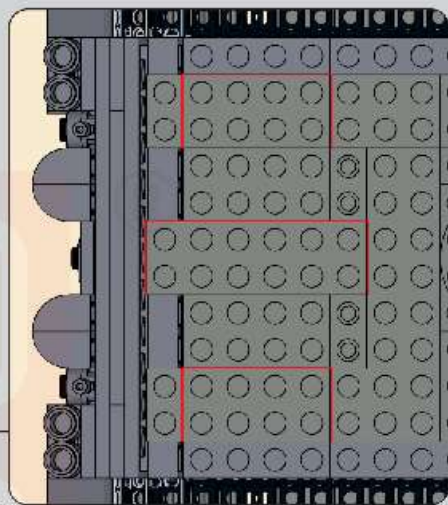
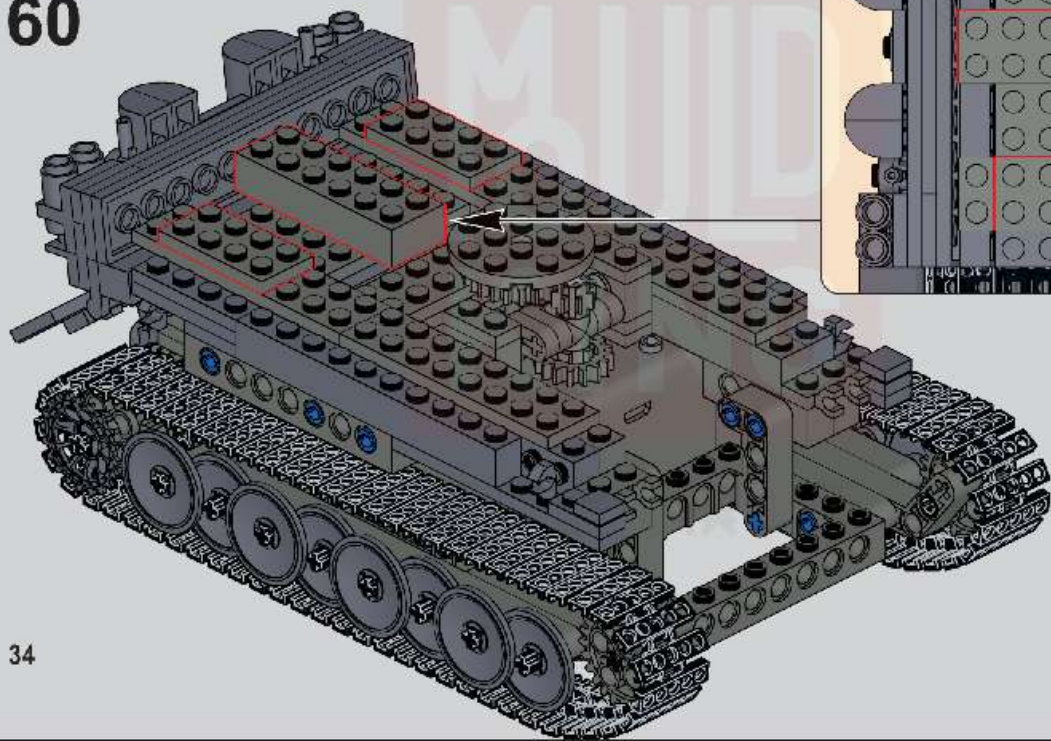

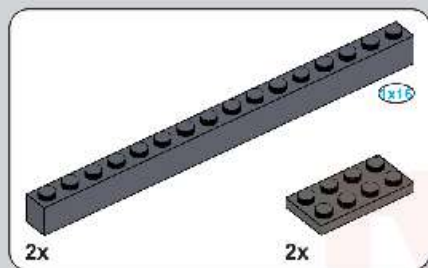

61

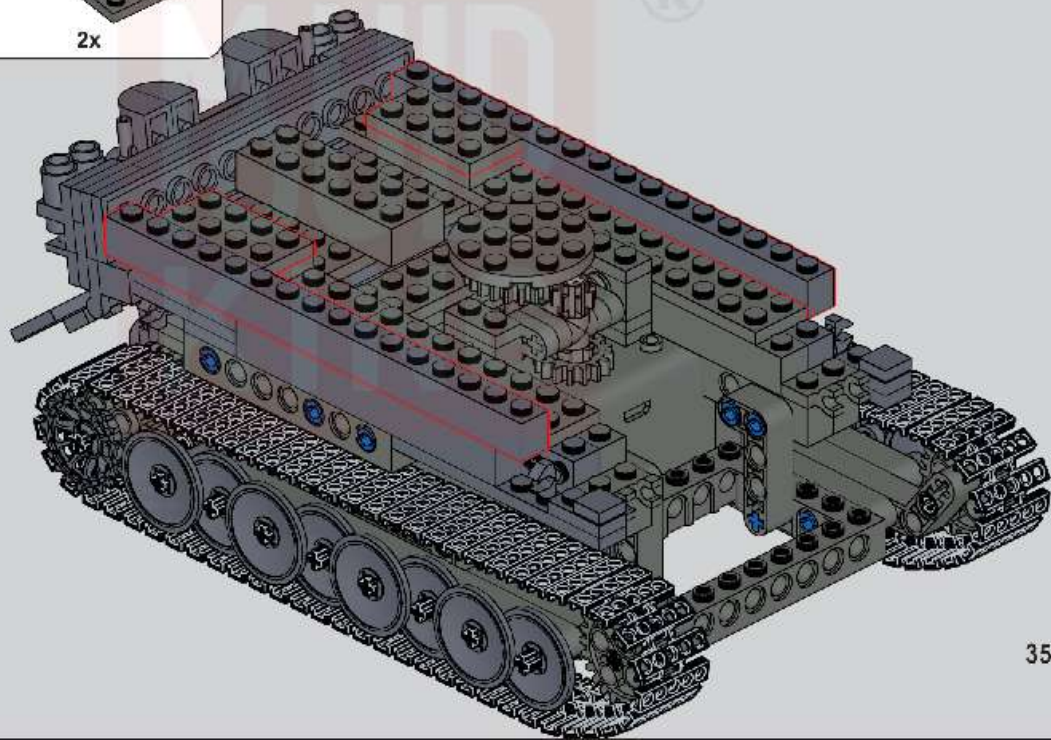

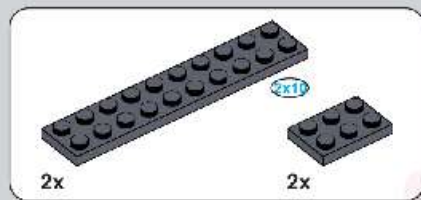

62

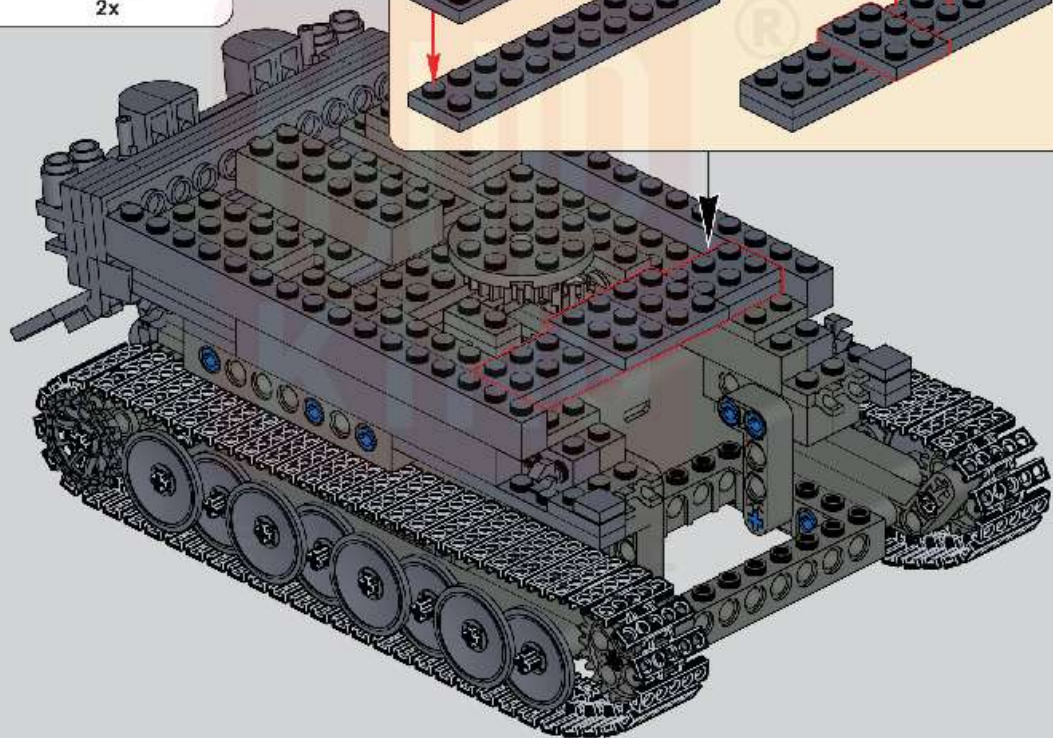
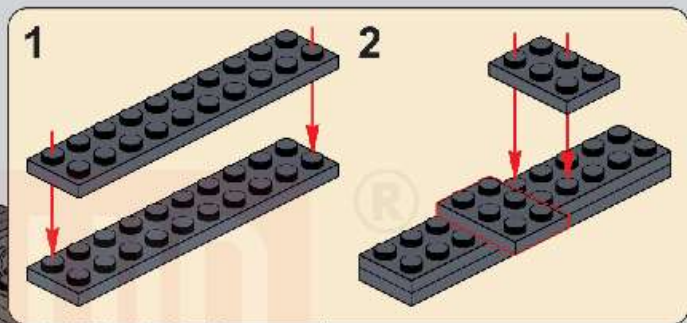

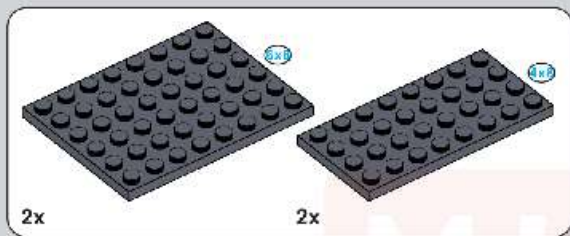

63

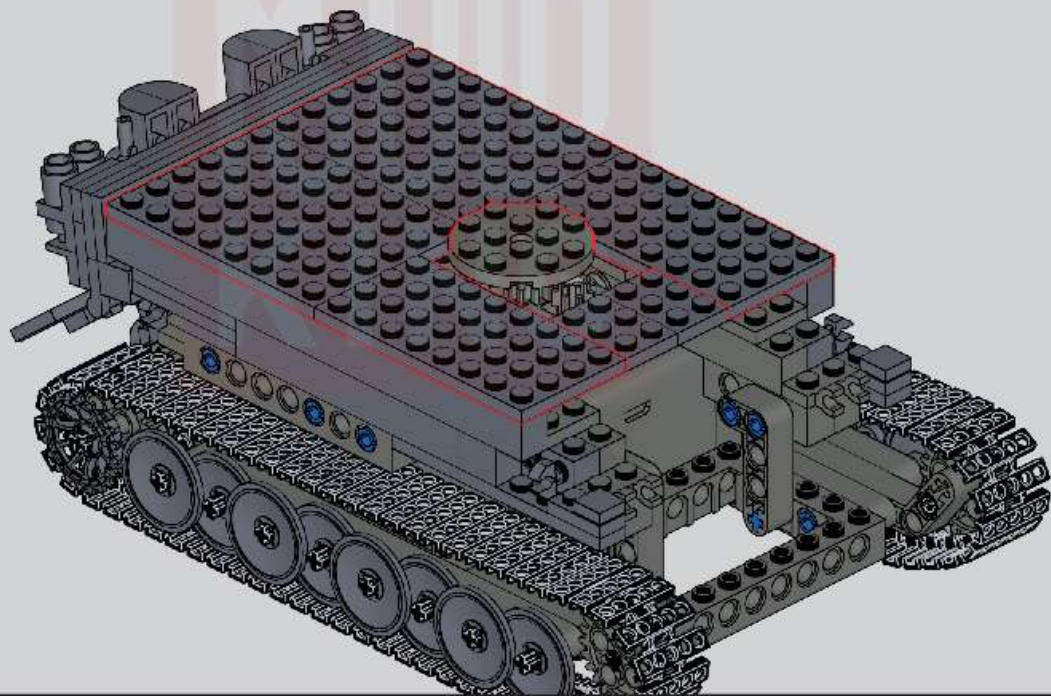

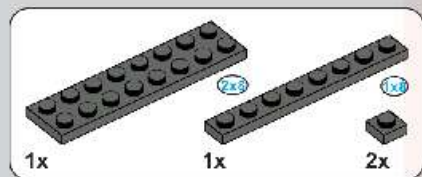
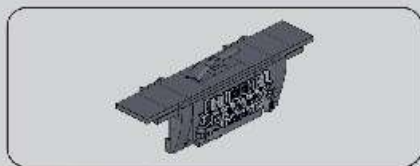
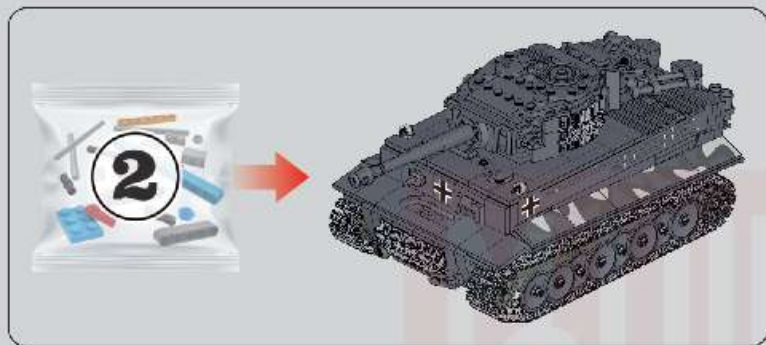

64

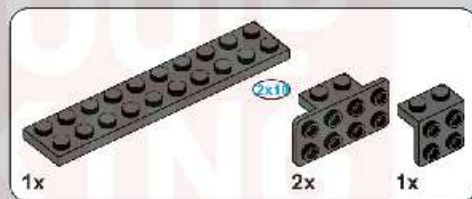
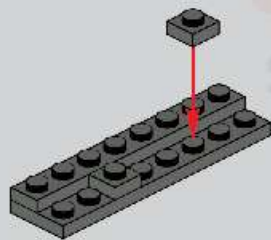

65

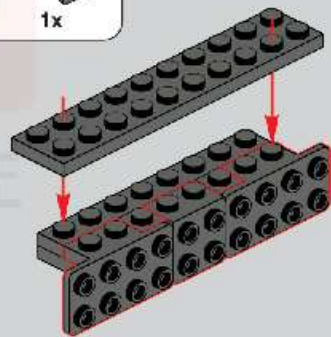

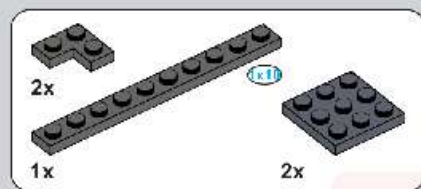

66

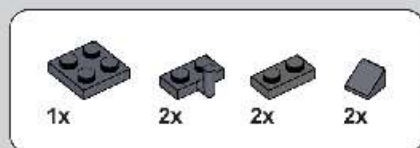
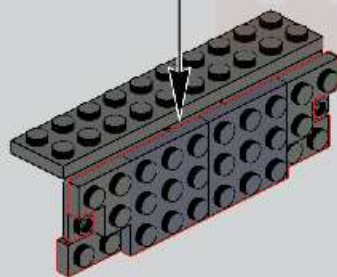
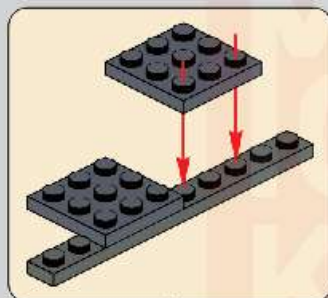

67

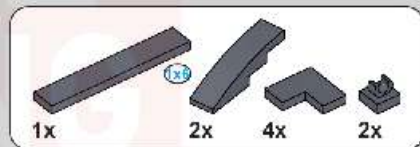
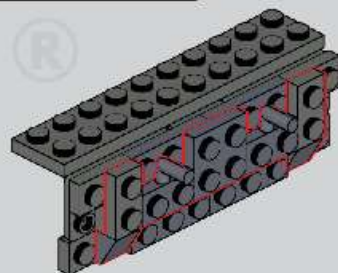

68

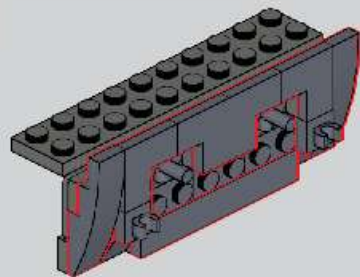

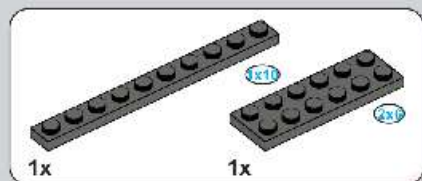

69

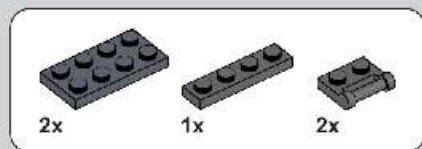
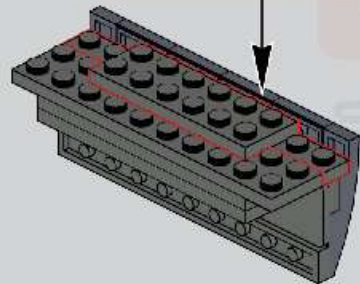
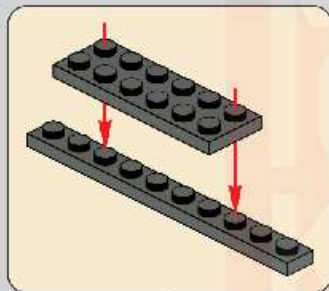

70

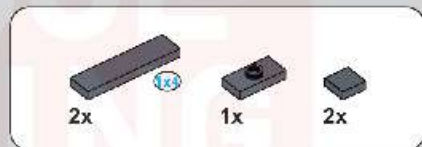
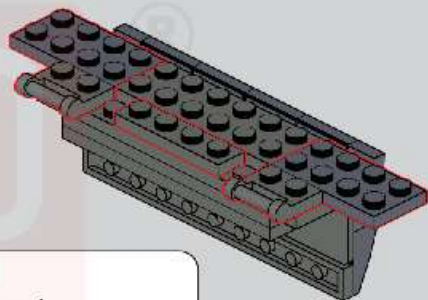

71

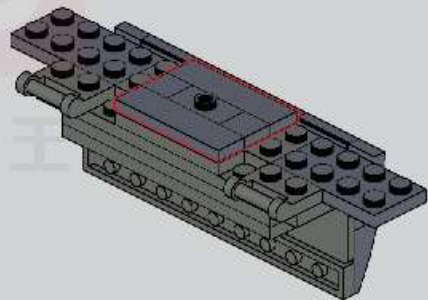



6x



1x

72

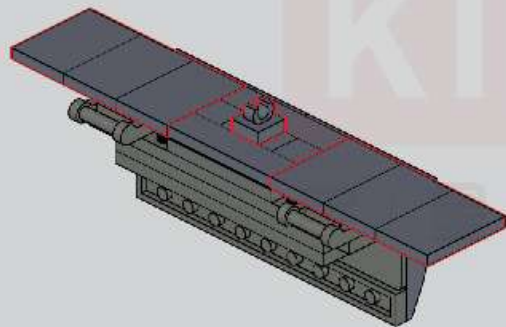

8x

73

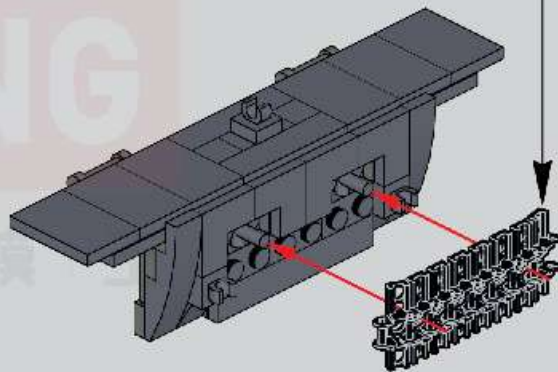
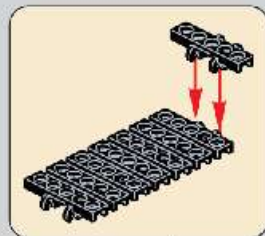



1x



2x

74

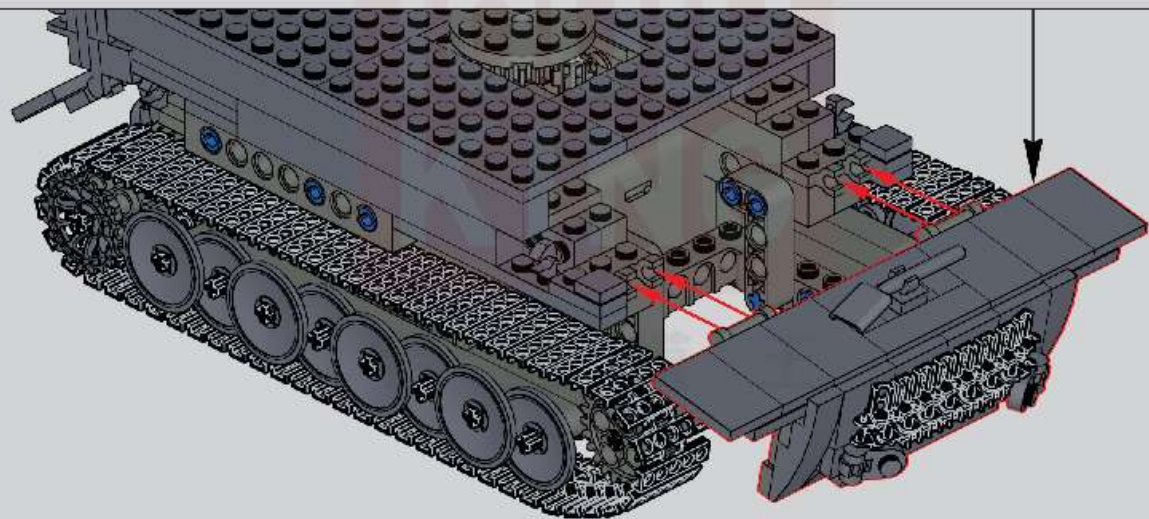
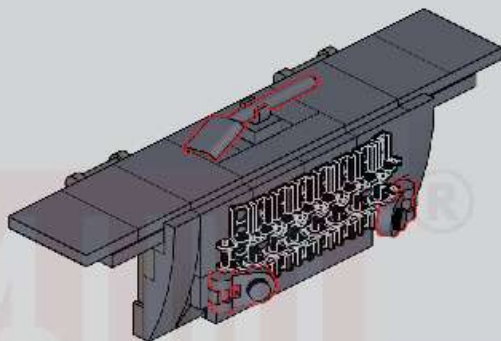

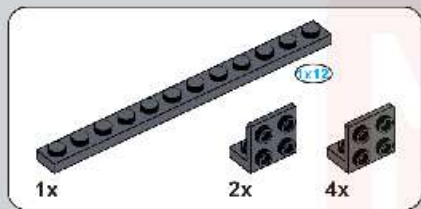
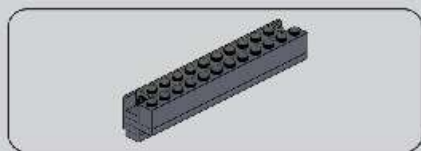

75

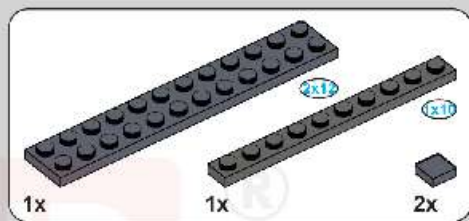
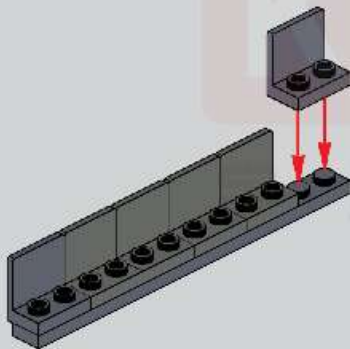

76

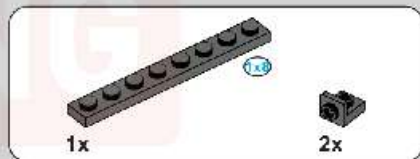
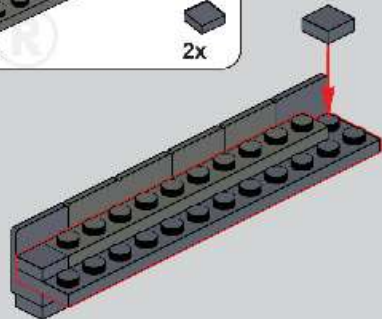

77

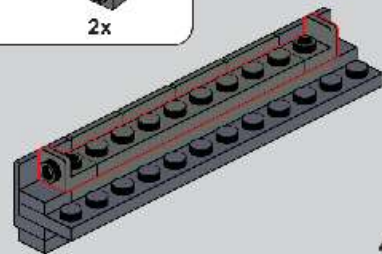

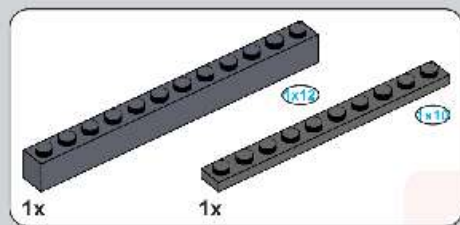

78

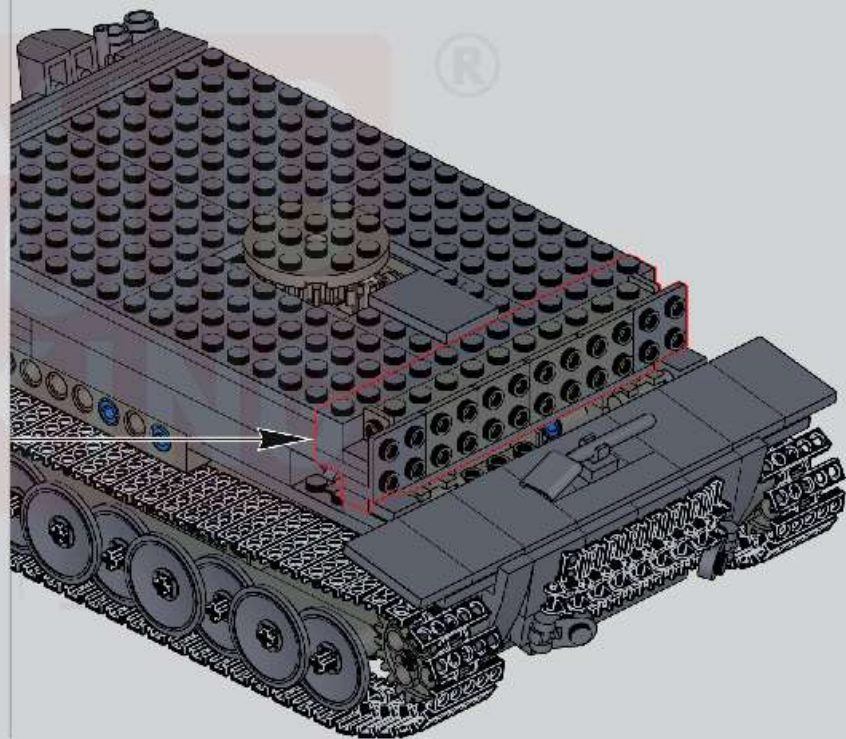
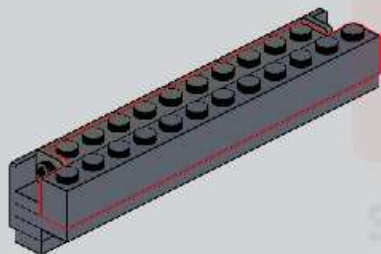

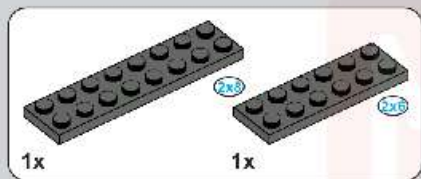
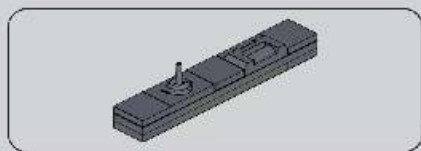

79

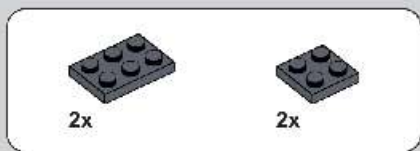
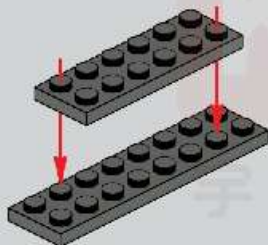

80

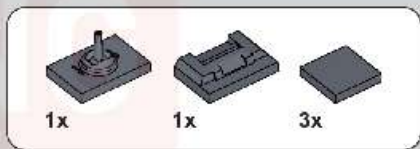
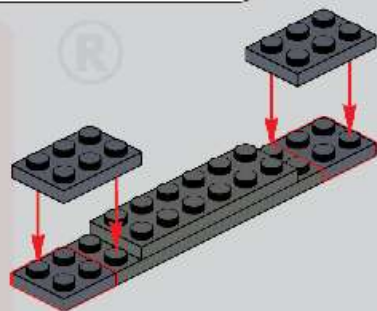

81

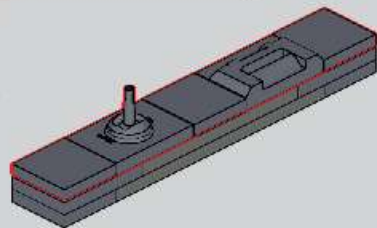

82

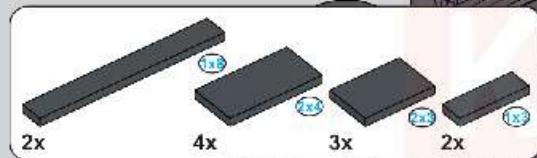
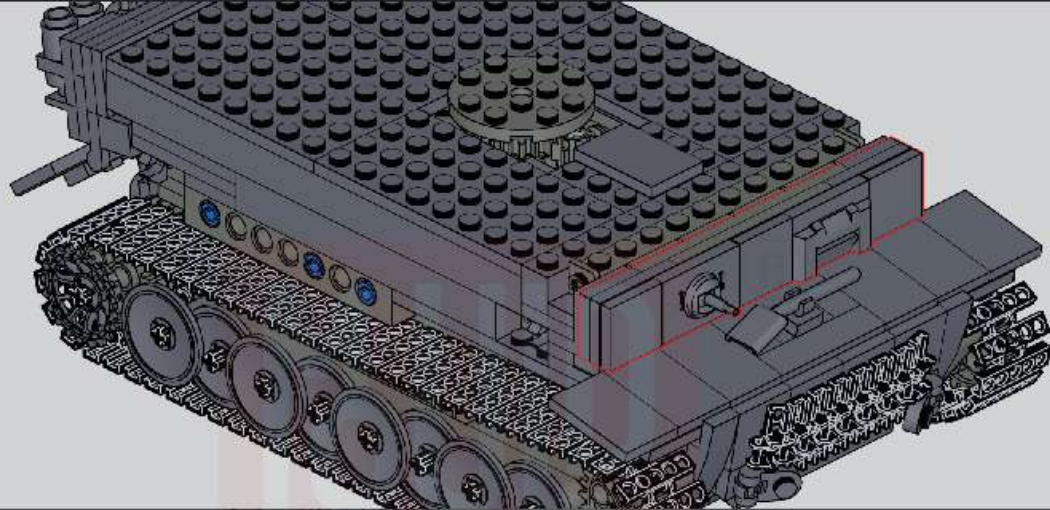

83

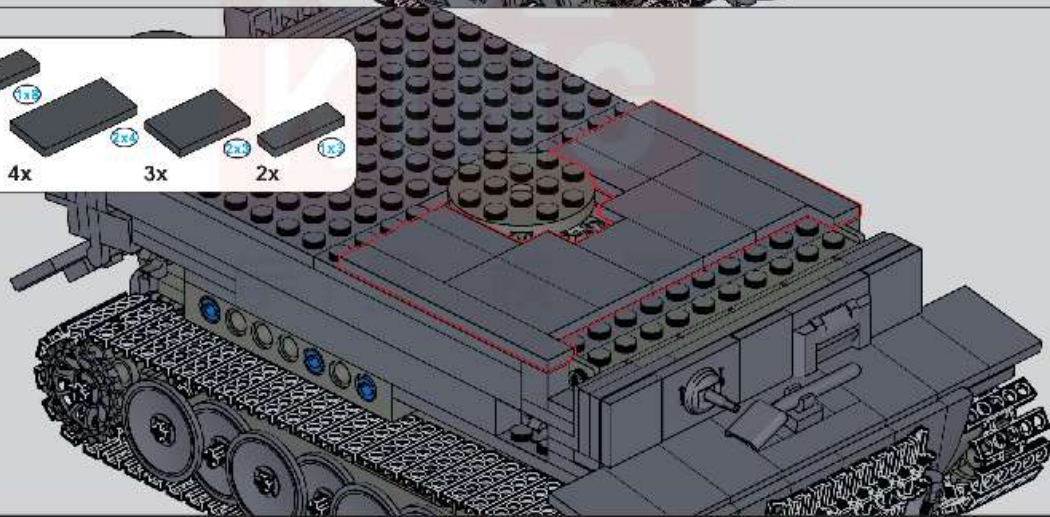



84

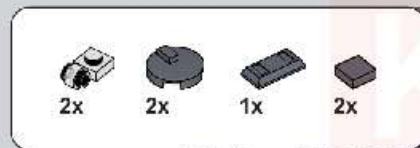
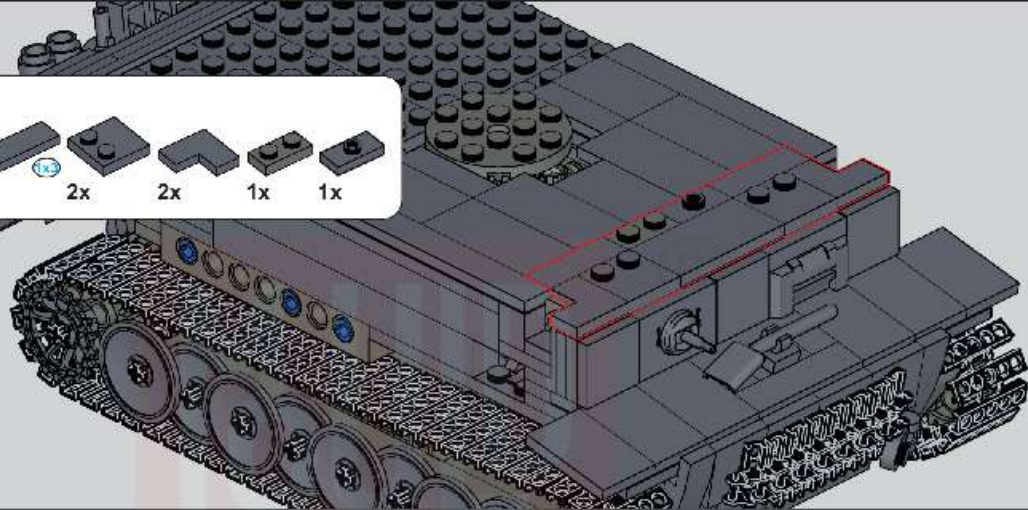

85

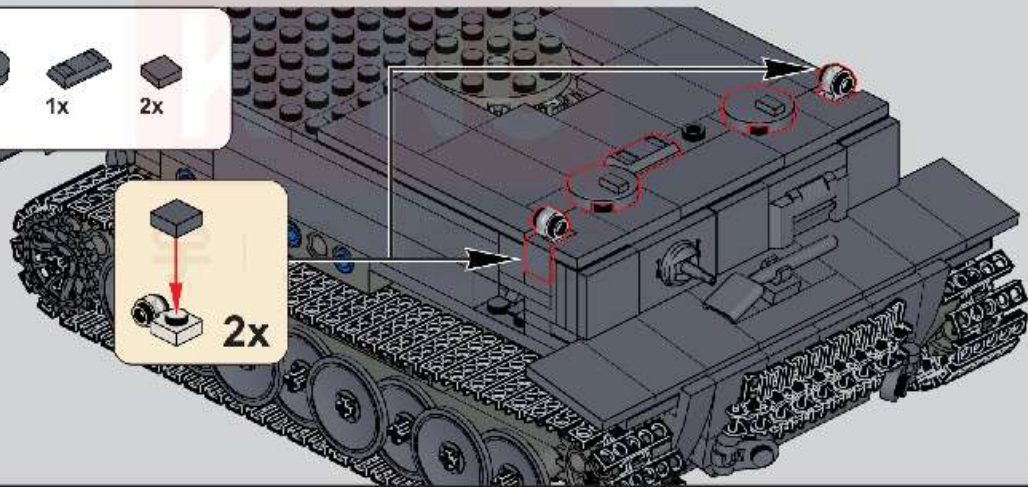

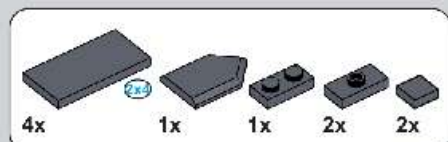

86

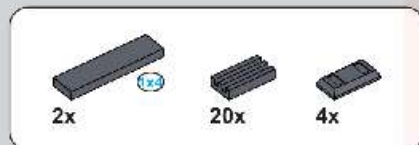
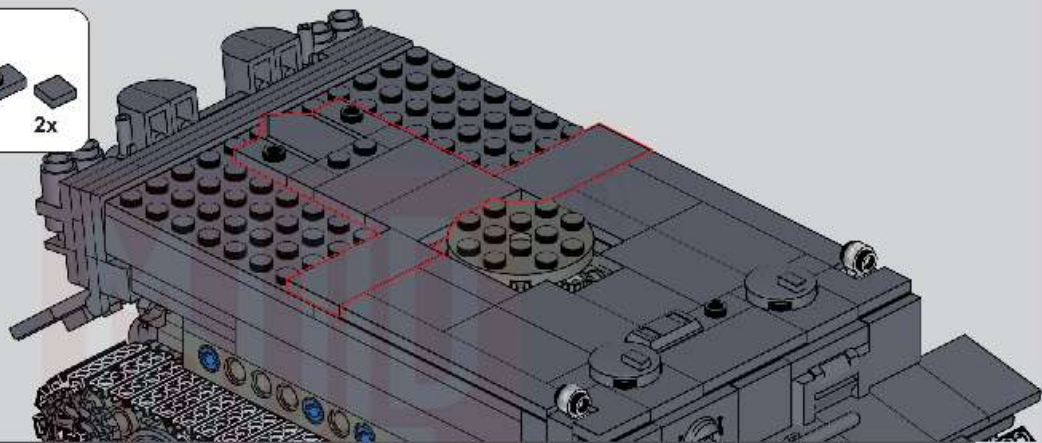

87

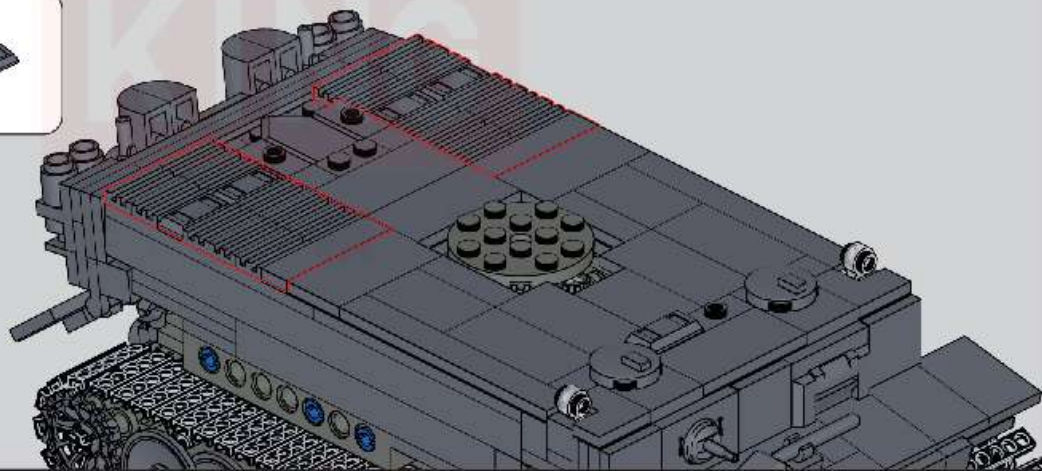



88

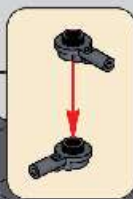
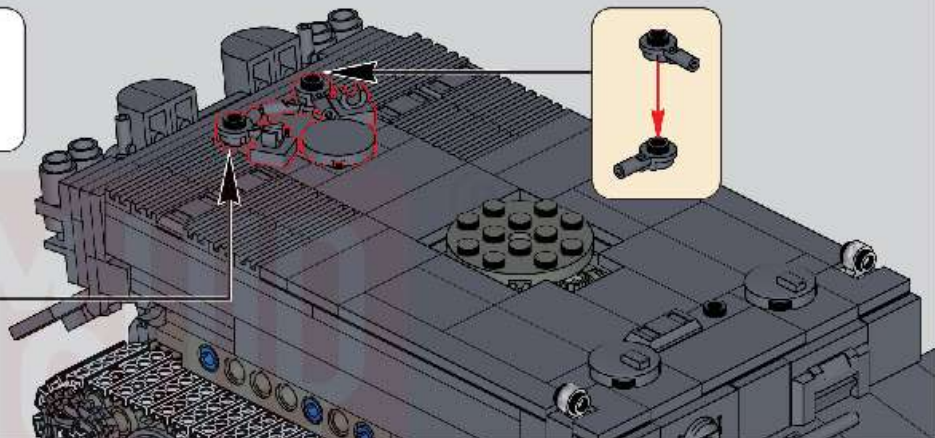
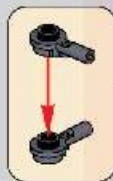

89

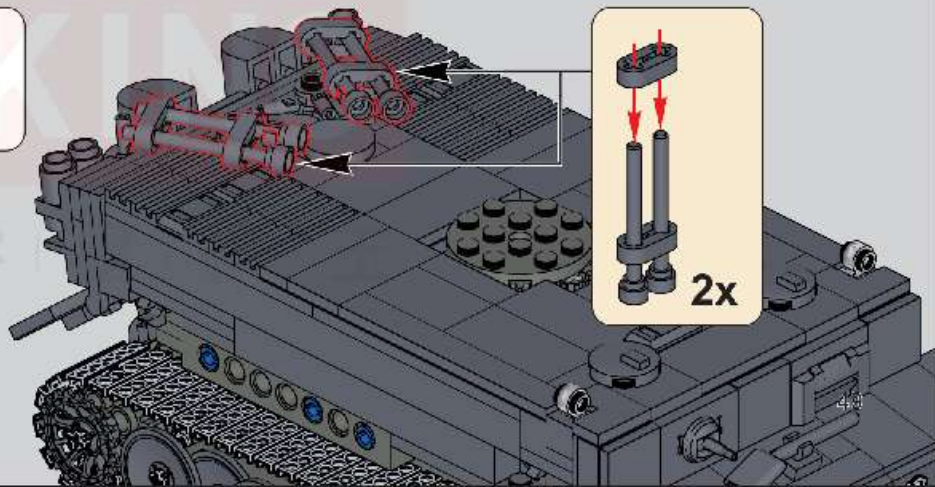
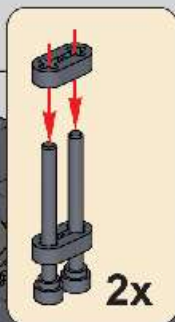

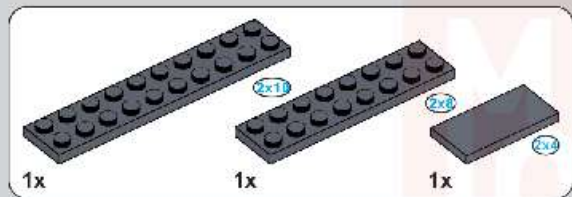
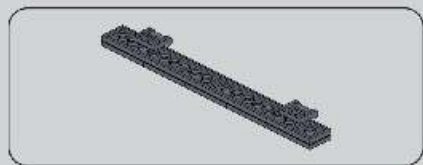

90

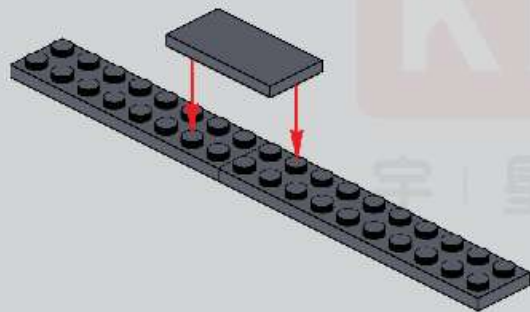

91

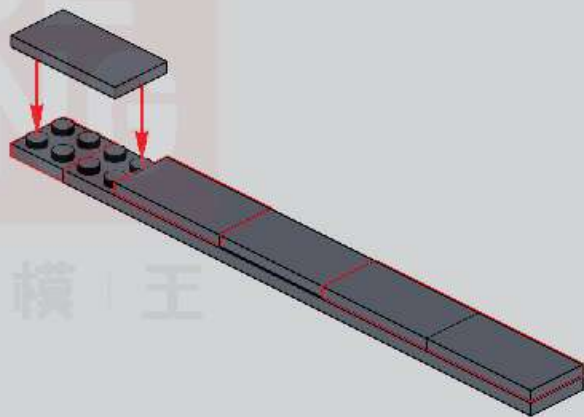



2x

92

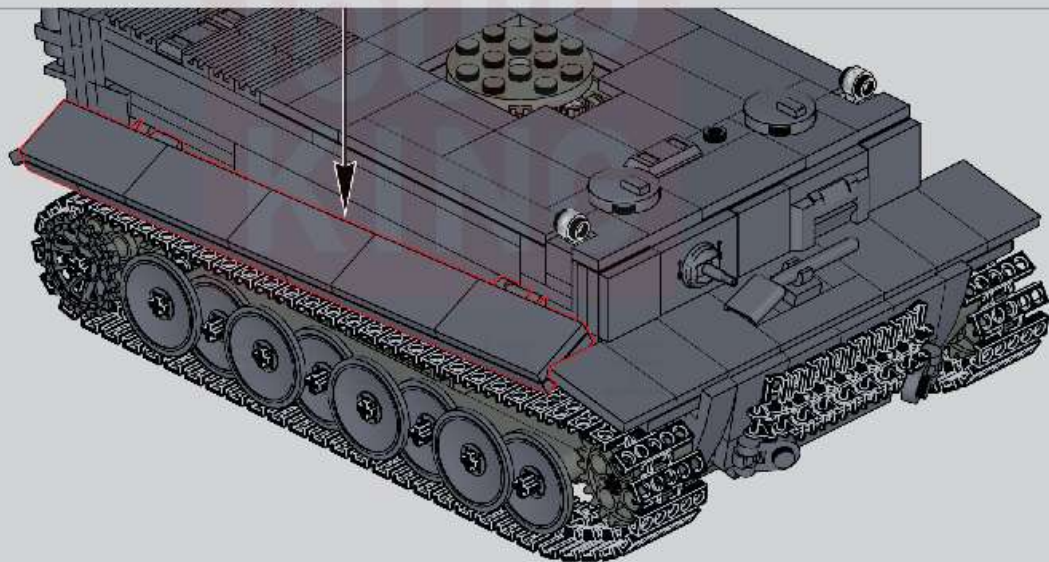
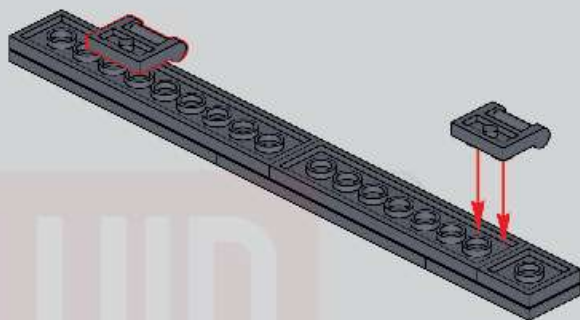

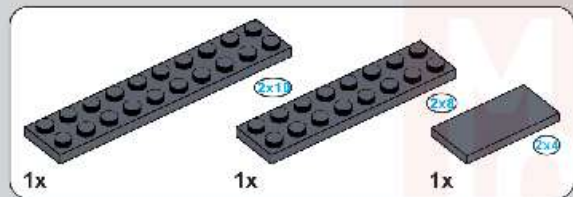
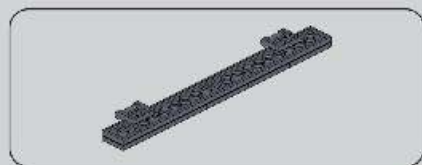

93

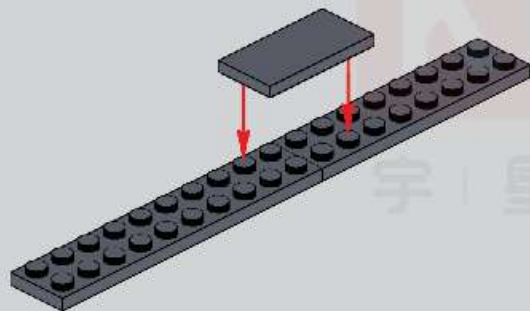

52



94

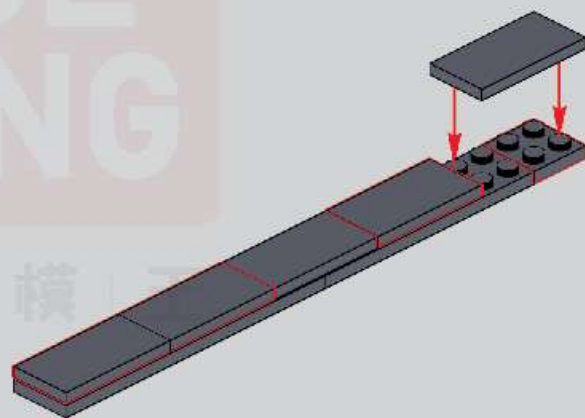



2x

95

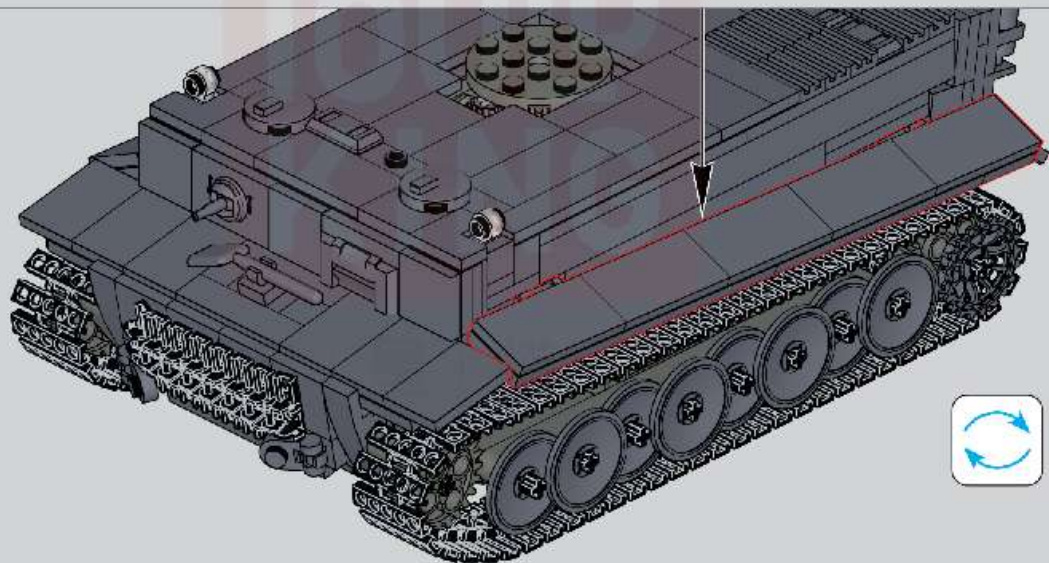
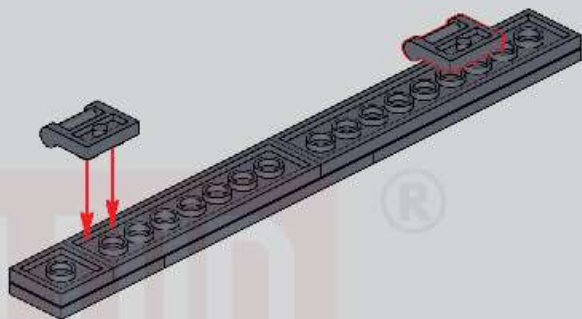

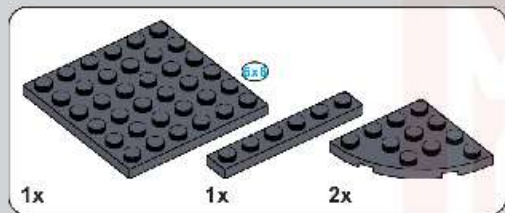
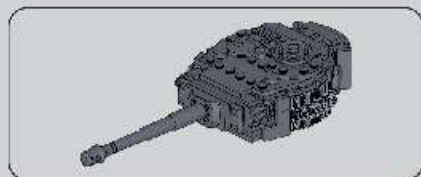

96

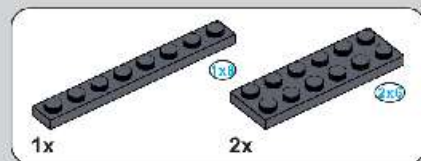
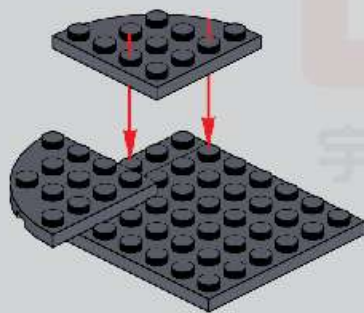

97

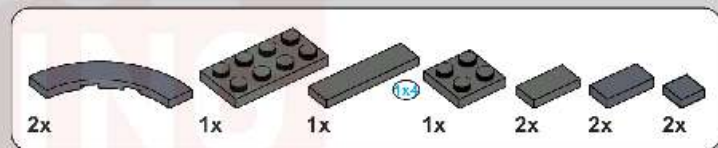
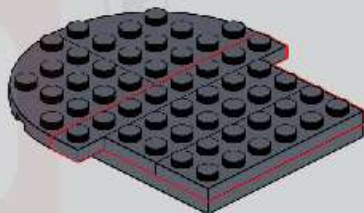

98

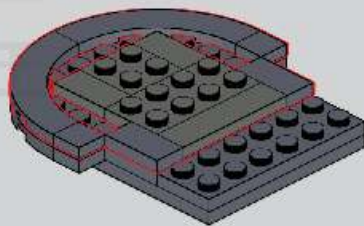

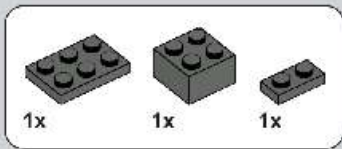

99

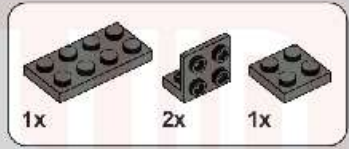
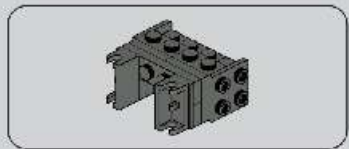
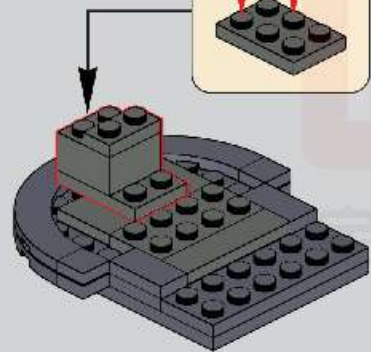
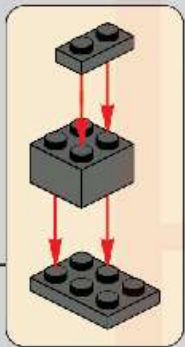

100

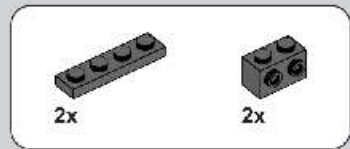
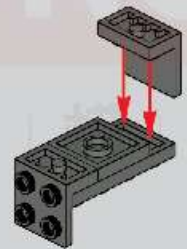

101

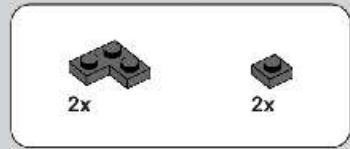
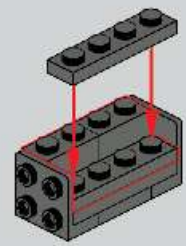

102

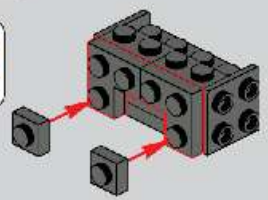



1x



2x

103

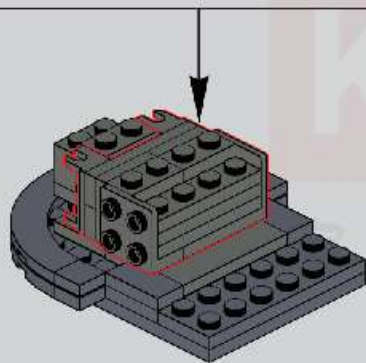
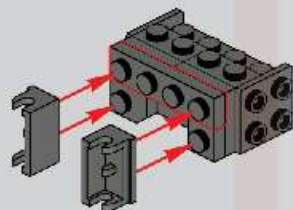

1x



2x

104

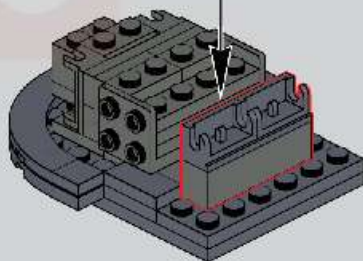
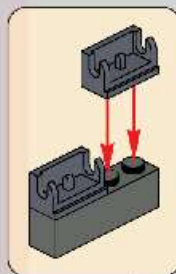

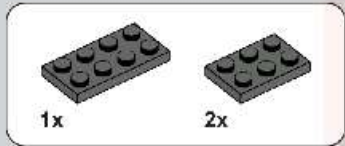
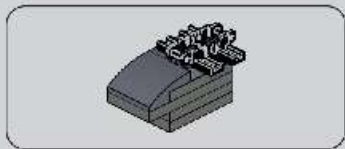

105

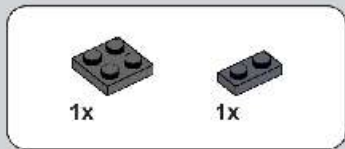
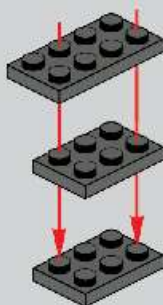

106

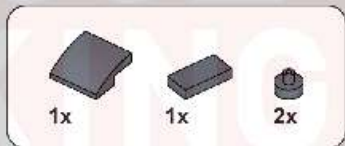
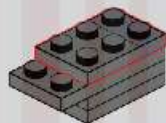

107

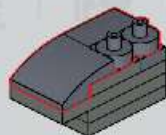

108

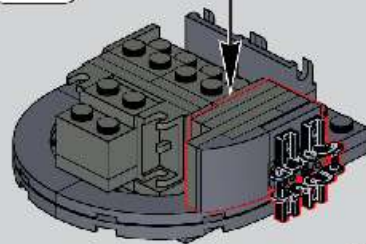
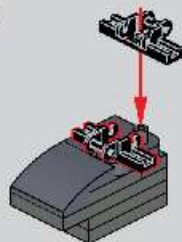

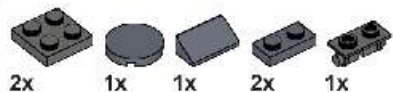

2x

1x

1x

2x

1x

109

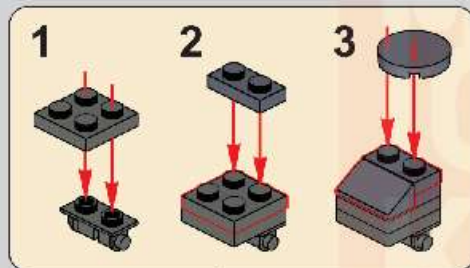

1

2

3

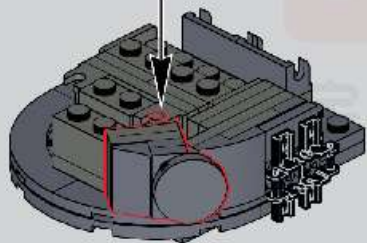

58



1x



1x



2x

110

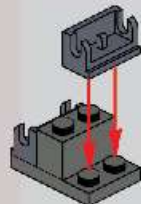

2x



1x



2x



2x

111

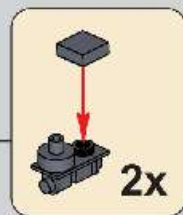
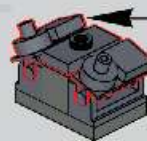

2x



5x

112

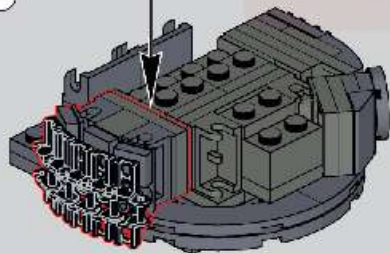
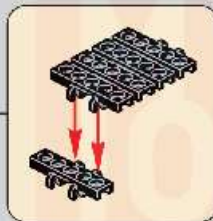
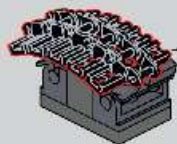

1x



1x



1x



1x



1x



1x



1x

113

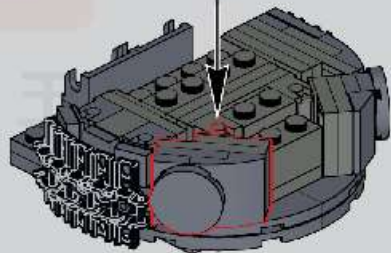
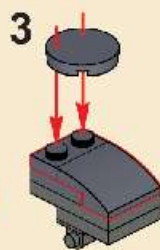
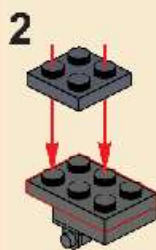

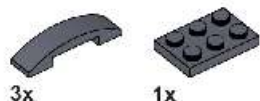
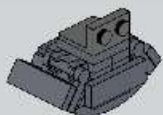

114

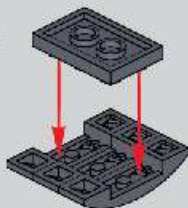

115

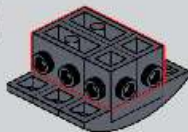

116

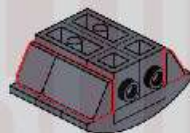

117

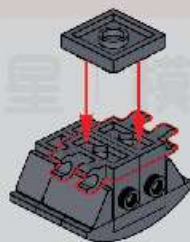

118

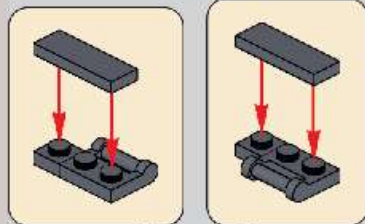

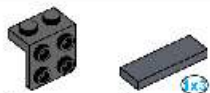

1x

1x



119

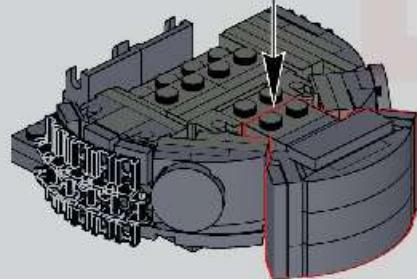
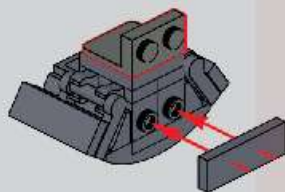

1x

1x

2x

120

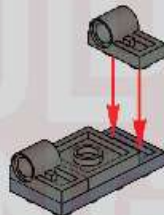

1x

2x

121

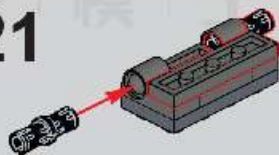

1x

2x

122

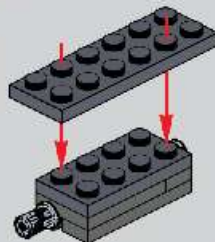

1x

2x

123

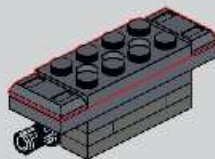

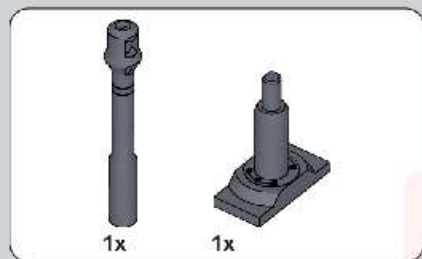

124

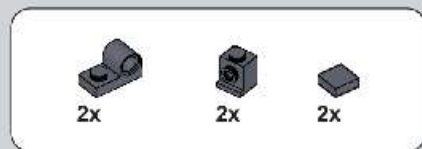
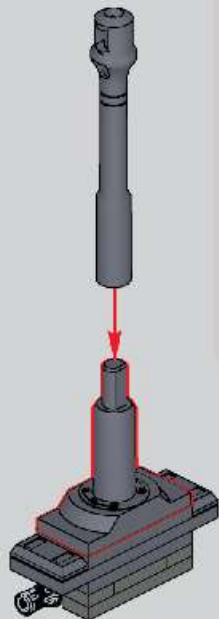

125

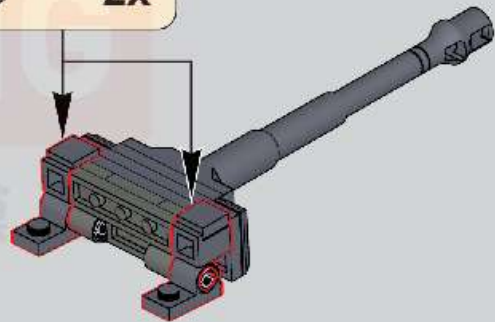
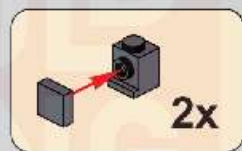

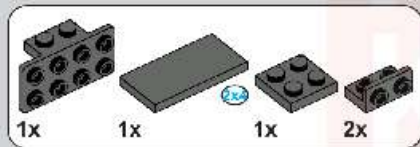
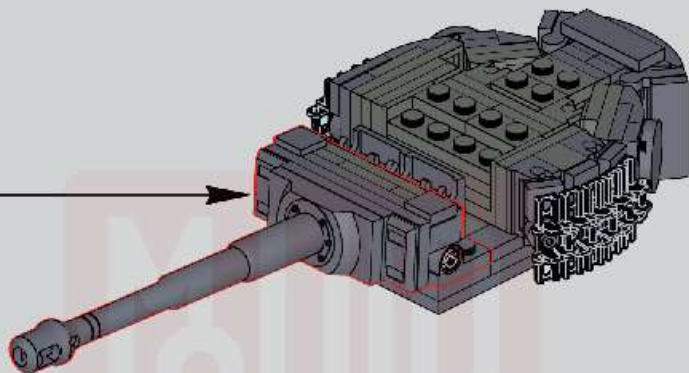

126

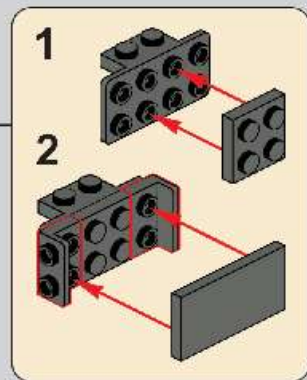
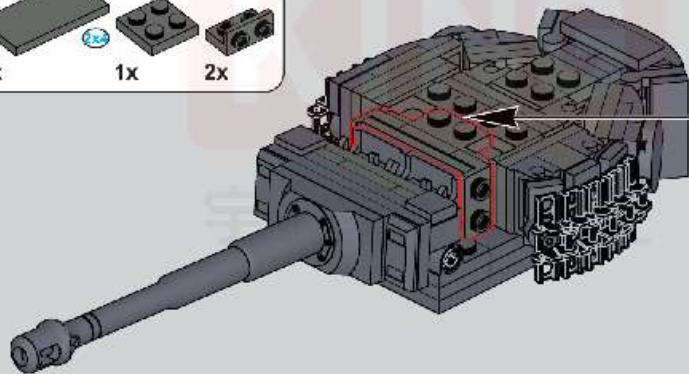

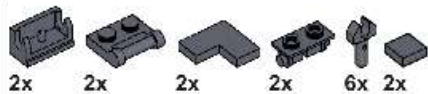

127

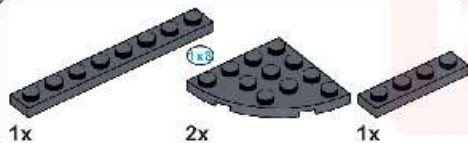
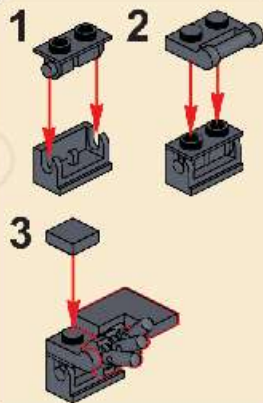
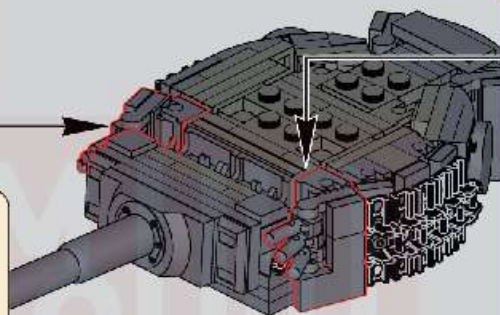
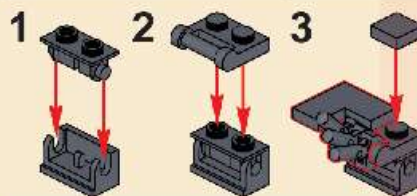

128

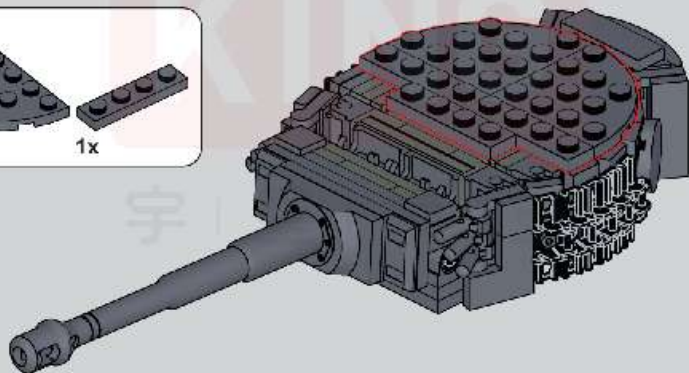



1x



2x

129

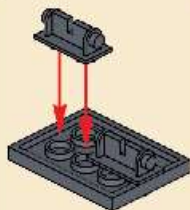
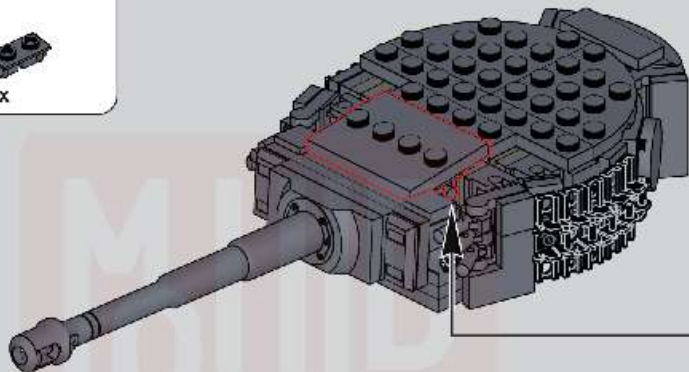

1x



1x



1x



1x

130

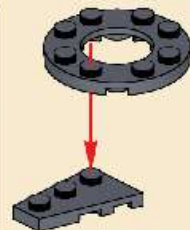
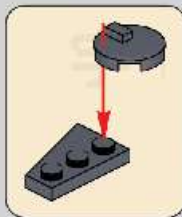
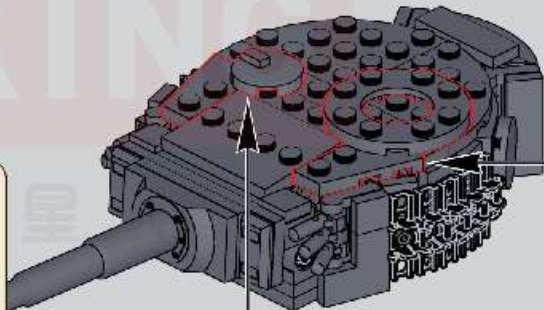

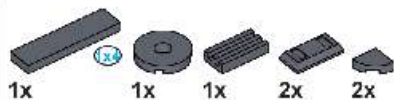

131

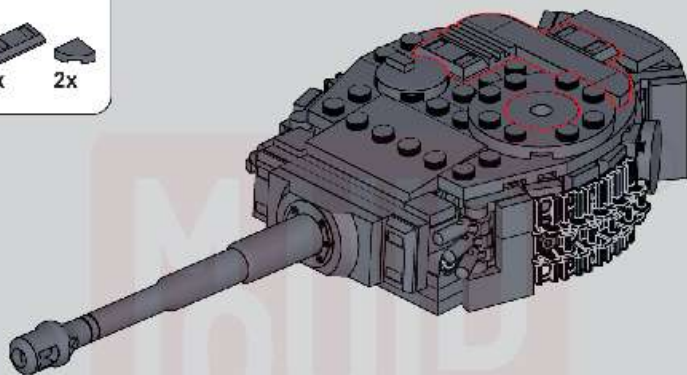

132

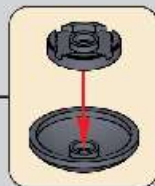
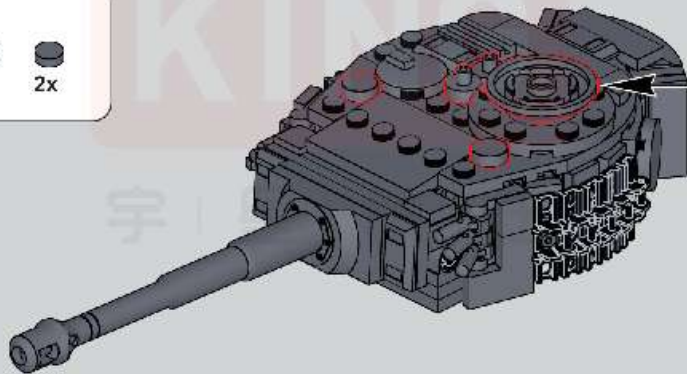

133

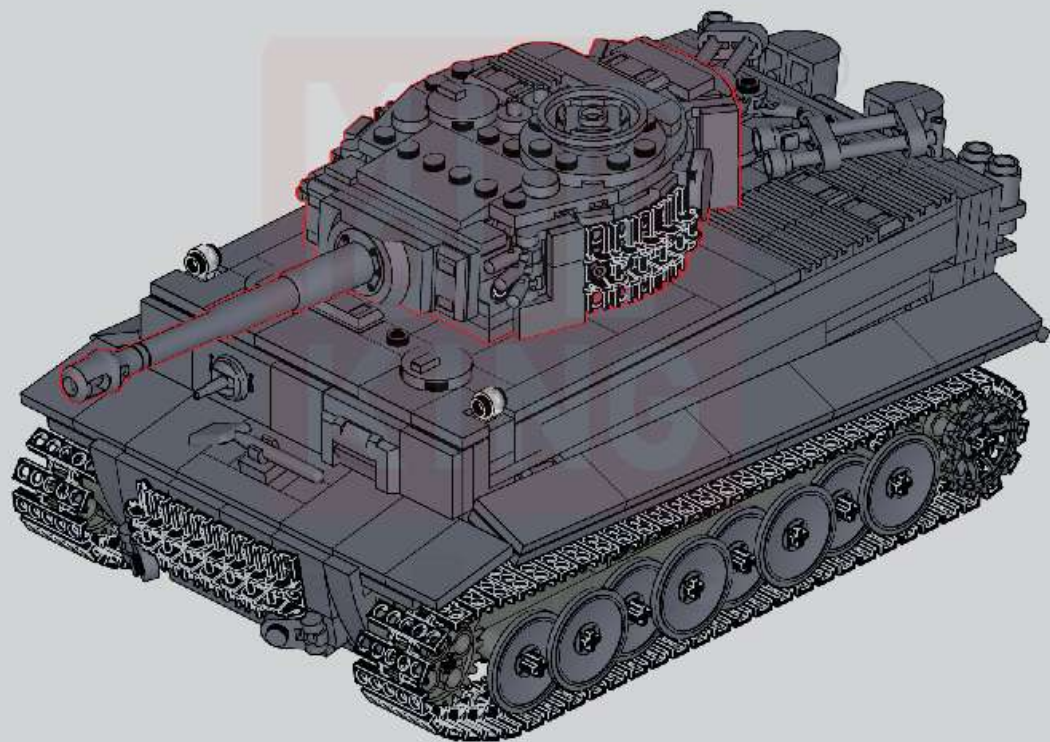

134

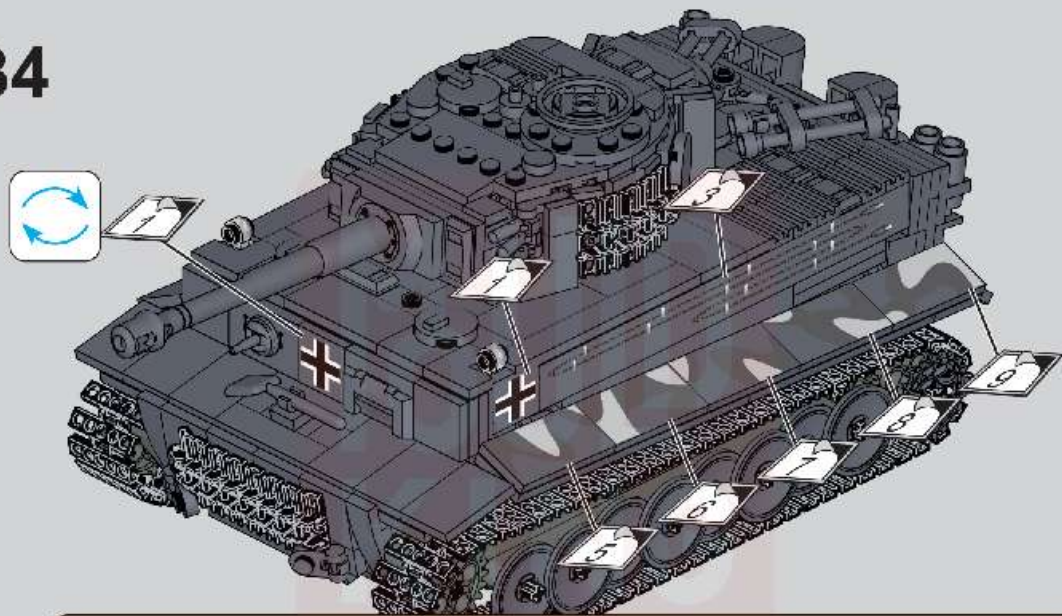

此贴纸为热感压标贴纸，不可重复粘贴

This sticker is a thermal pressure label sticker and cannot be pasted repeatedly

贴纸使用方法：撕起贴纸，对准位置随后均匀刮动，撕掉透明膜即可。

How to use the sticker: Tear off the sticker, align the position and then scrape it evenly, tear off the transparent film.

135

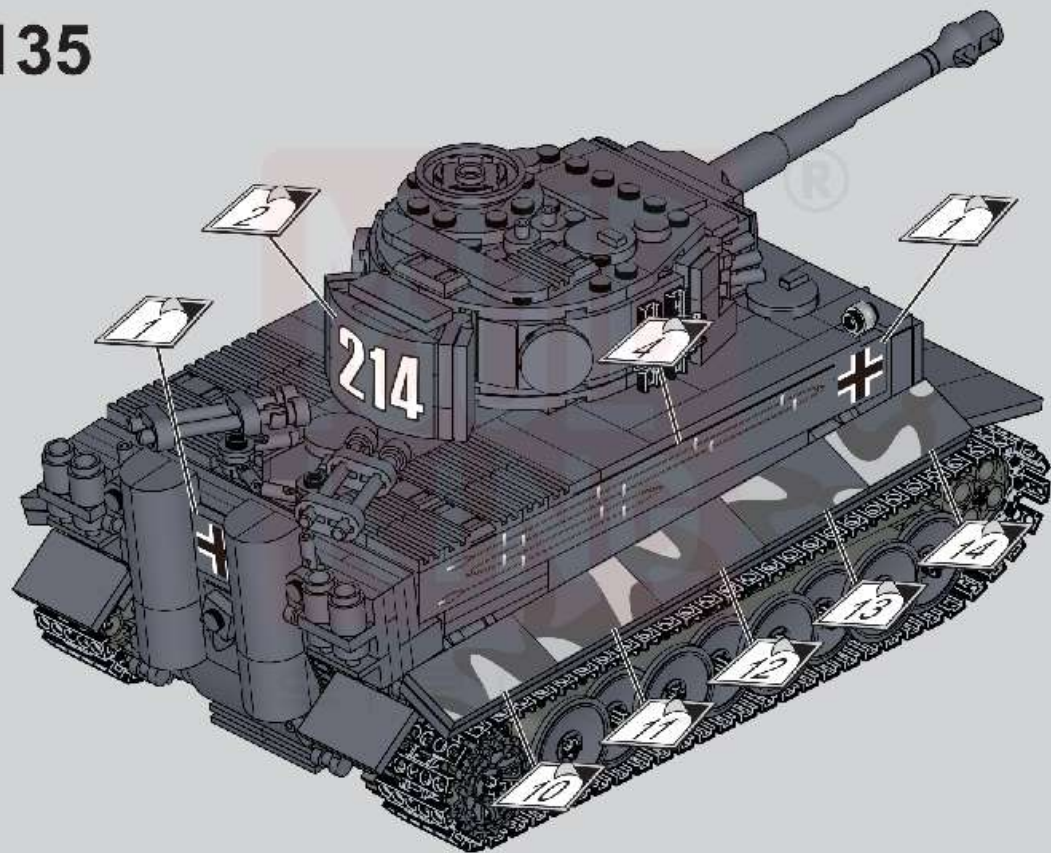

136

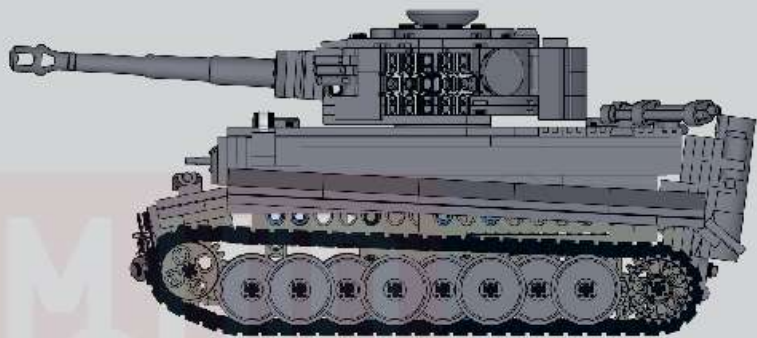
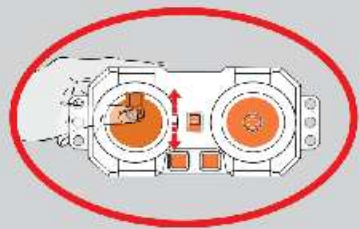

137

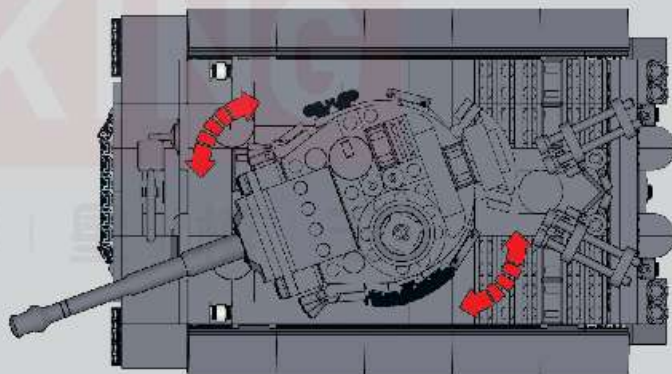
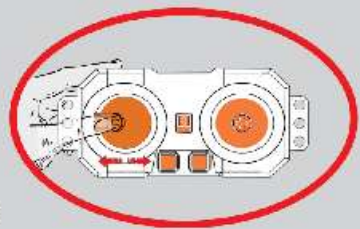

138

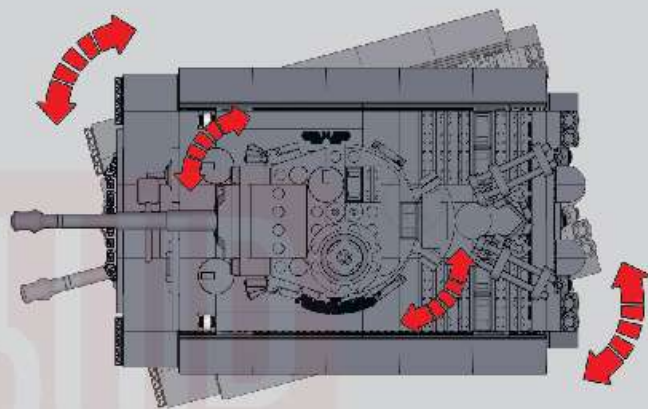
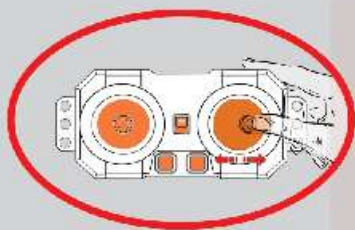

139

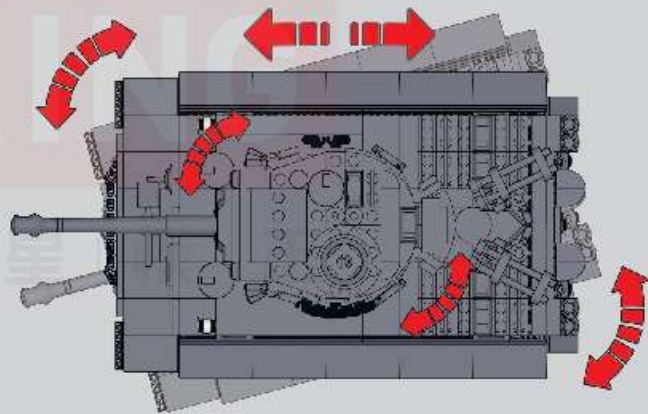
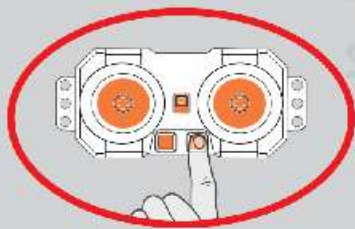



宇 | 皇 | 模 | 王

