



宇星模王



豹2坦克
NO. LEOPARD 2 TANK

20020





豹2A6是一款坦克，最大的特点是换装了55倍口径的120毫米滑膛炮，炮口初速达到1750米每秒，强力的装甲和动力系统。
Leopard 2 A6 is a tank. The biggest feature is that it is equipped with 120 tanks with 55 caliber Millimeter smooth bore gun, muzzle velocity reaches 1750 meters per second, powerful armor and movementForce system.

火炮是德国莱茵公司120毫米滑膛炮, 55倍口径Rh120-L55滑膛炮, 炮口初速达到1750米/秒, 使用DM53钨合金弹, 在2000米上穿深约670毫米, 而且精度相当高。最大射程5000米, 为目前射程最远的坦克火炮。火控系统先进, 反应时间6秒。

机枪1挺莱茵金属公司的MG3A1式7.62mm并列机枪, 安装在120mm火炮左侧, 射速为1200发/min; 一挺安装在装填手枪盖环形支架上的MG3A1式7.62mm高射机枪, 用于防空, 高低射界为 $-10^{\circ}\sim+75^{\circ}$ 。

The artillery is a 120 mm smooth bore gun of German Rhine Company, 55 times the caliber Rh120-L55 smooth bore gun, with muzzle velocity of 1750 m/s, and DM53 tungsten alloy projectile, with a penetration depth of about 670 mm at 2000 m, and high accuracy. The maximum range is 5000 meters, which is the tank artillery with the longest range at present. The fire control system is advanced, and the reaction time is 6 seconds.

One MG3A1 type 7.62mm parallel machine gun of Rhine Metal, installed on the left side of 120mm gun, with a firing rate of 1200 rounds/min; A MG3A1 7.62mm anti-aircraft machine gun installed on the annular support of the loading hand hatch cover is used for air defense, with a high and low firing range of $-10^{\circ}\sim+75^{\circ}$.





MB873Ka-501型4冲程12缸V型90°夹角水冷预燃室式增压中冷柴油机,是目前世界上最好的柴油发动机之一。具有比较好的加速性能,从零加速到32公里/小时仅需6秒。发动机功率1100千(1500马力)。最大速度可达72公里/小时。

MB873Ka-501 4-stroke 12 cylinder V-type 90 ° angle water-cooled precombustion chamber turbocharged intercooled diesel engine is one of the best diesel engines in the world. It has good acceleration performance. It only takes 6 seconds to accelerate from zero to 32 km/h. The engine power is 1100 kW (1500 HP). The maximum speed can reach 72 km/h.

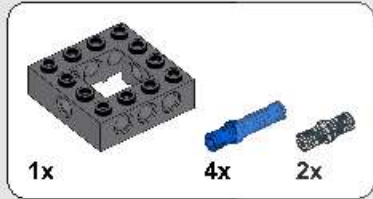
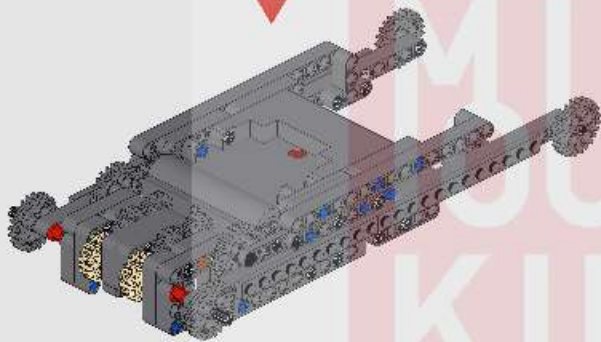

1

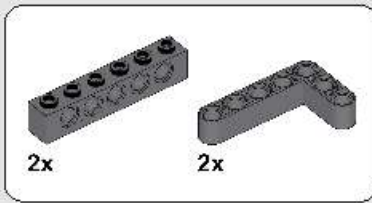
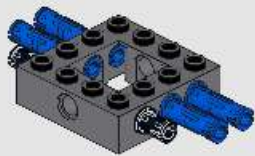

2

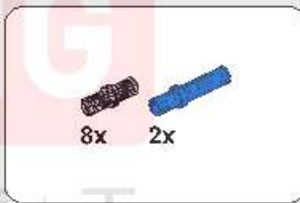
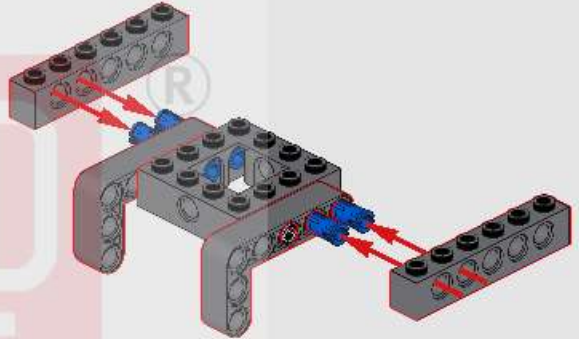

3

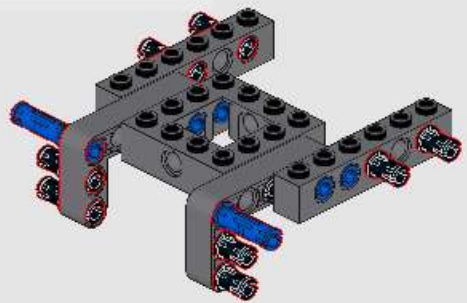

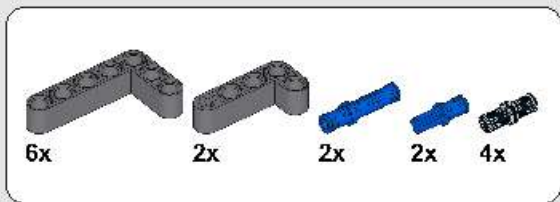

4

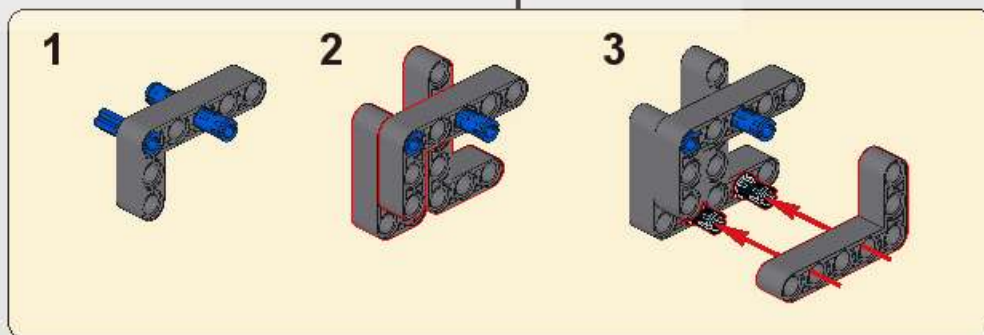
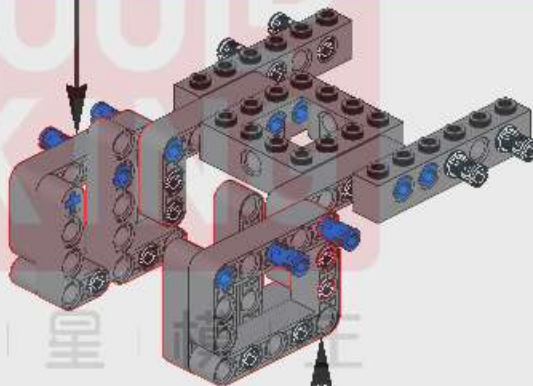
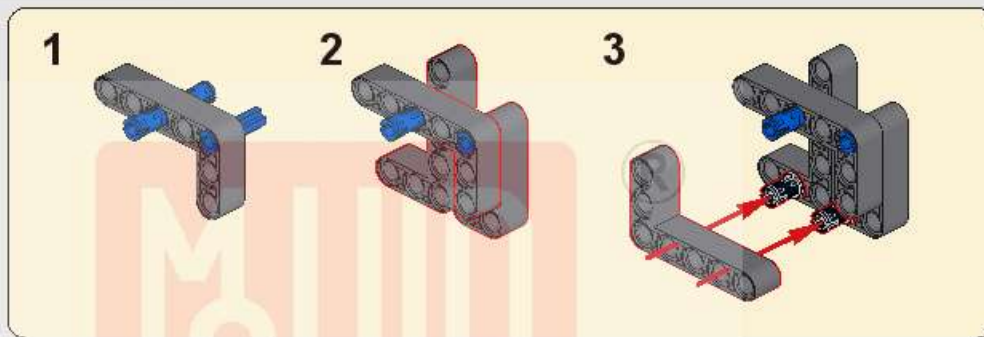

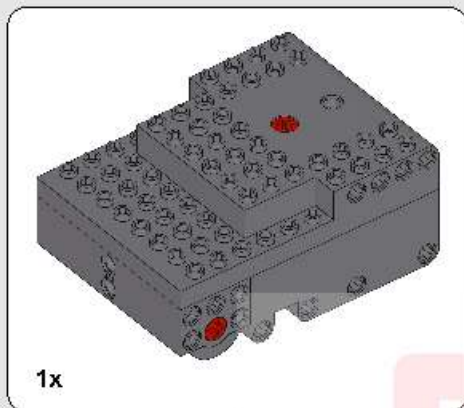

5

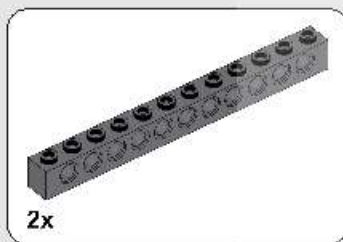
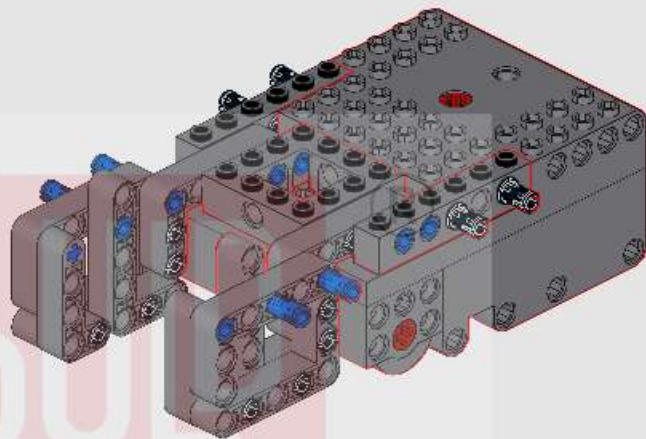

6

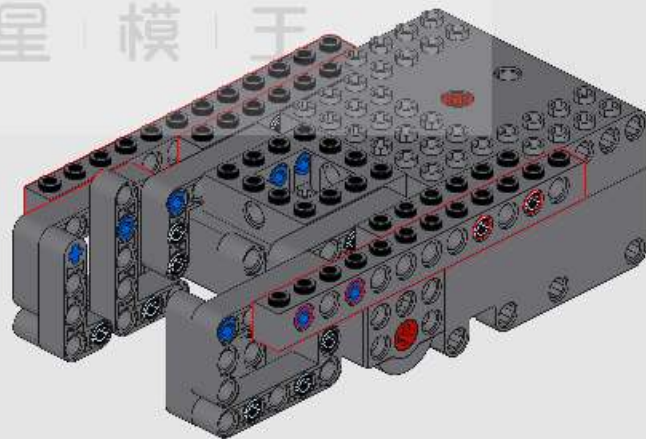

MOUL
KING
宇 | 星 | 模 | 王

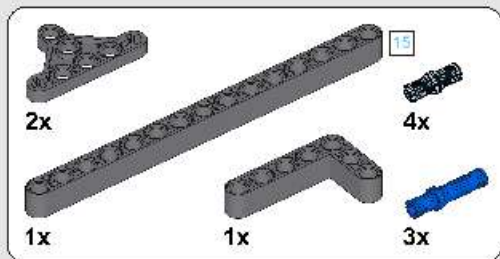

7

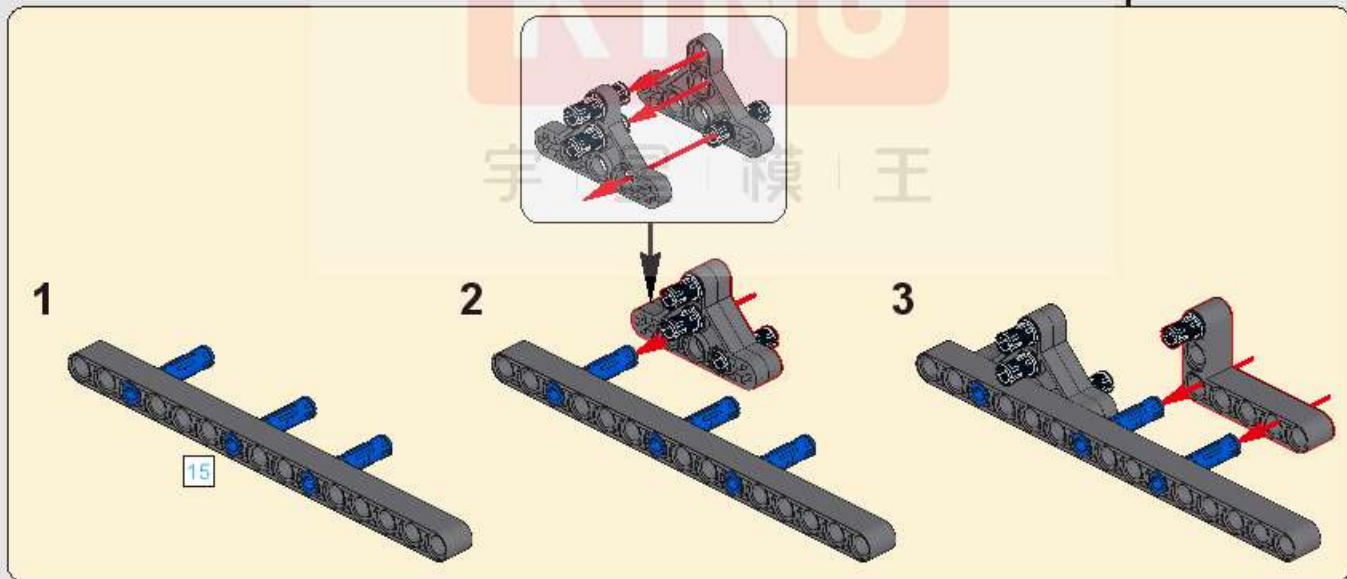
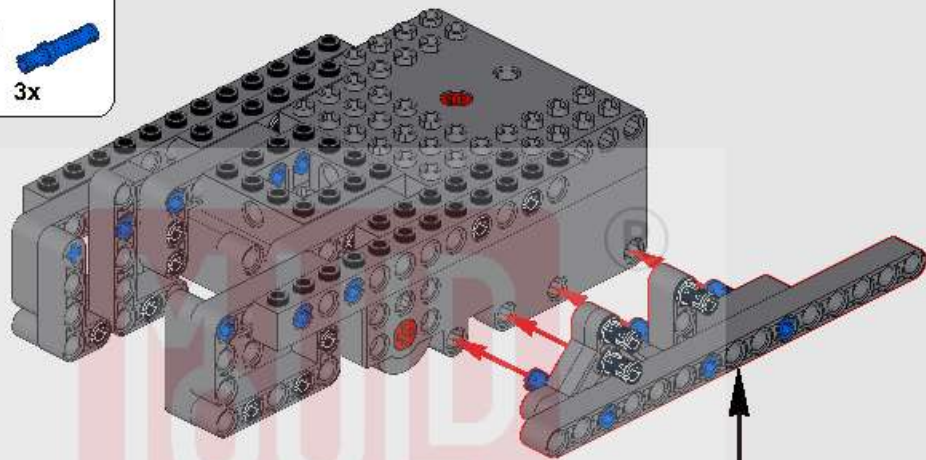

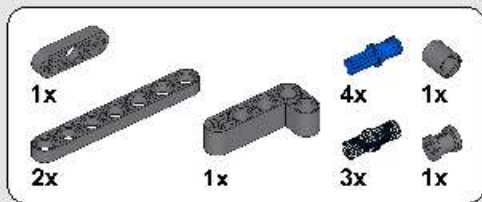

8

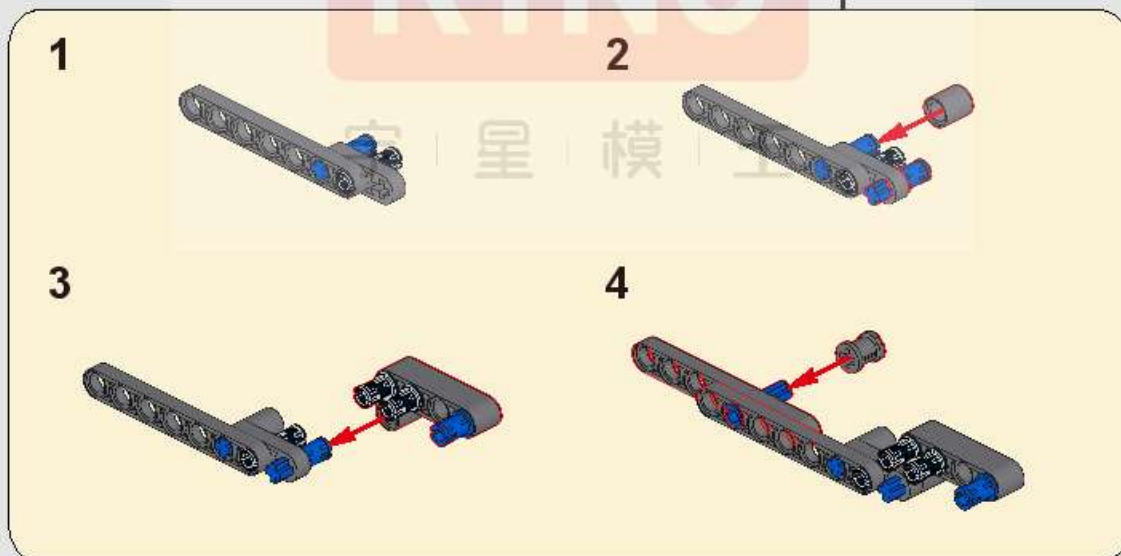
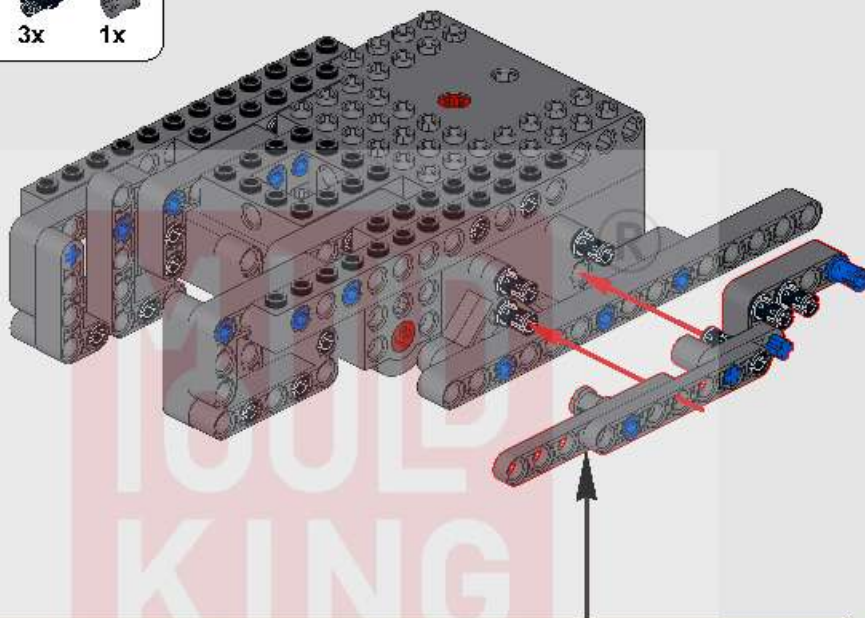

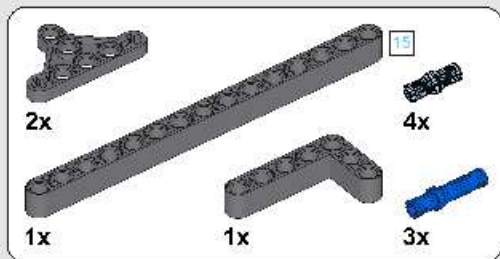

9

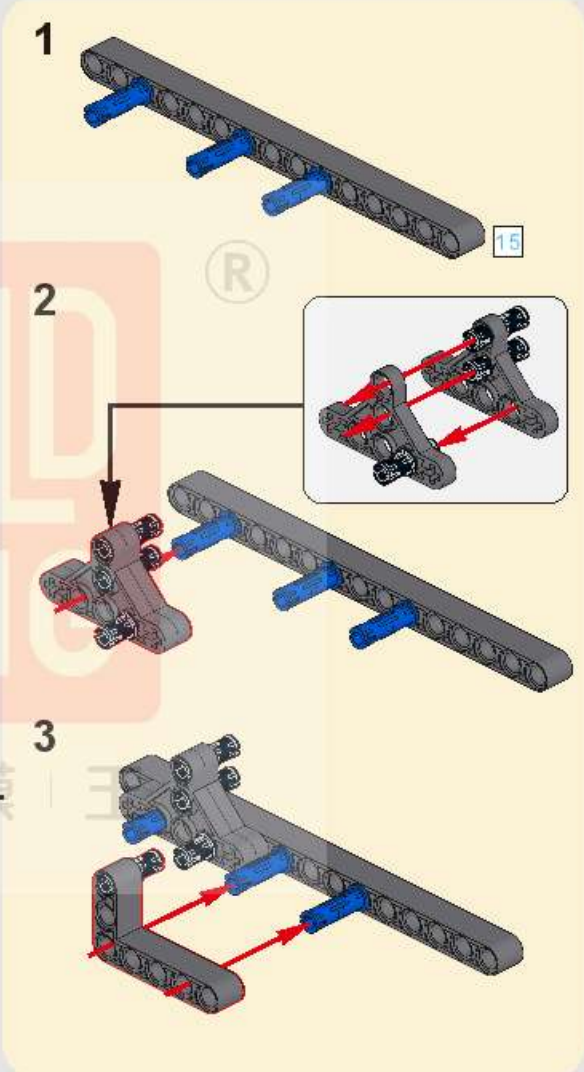
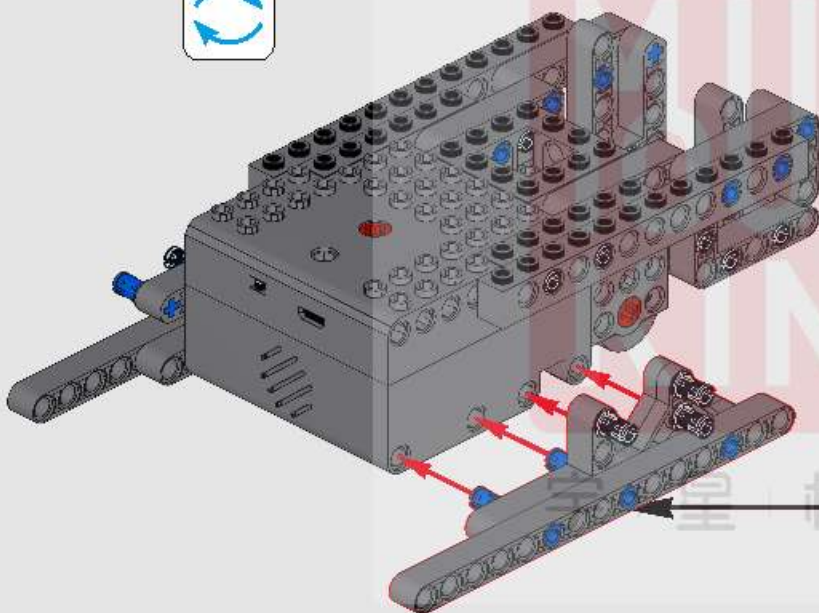

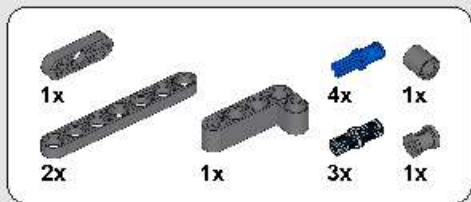

10

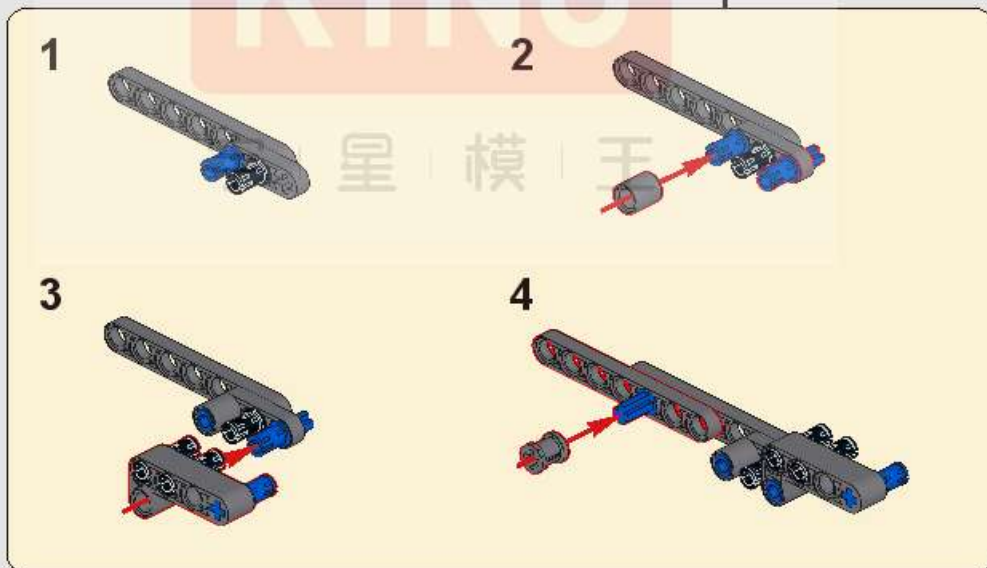
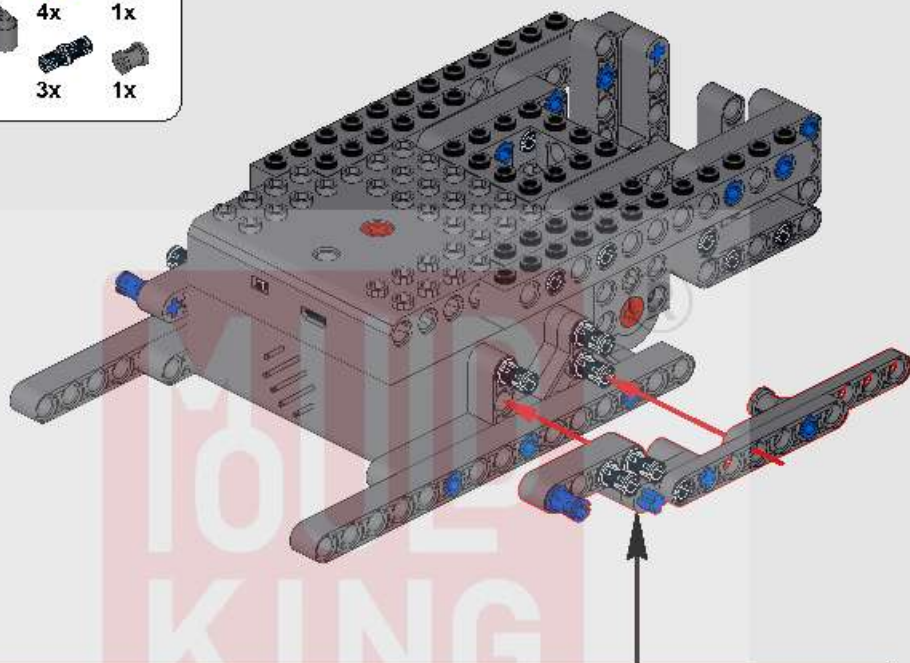

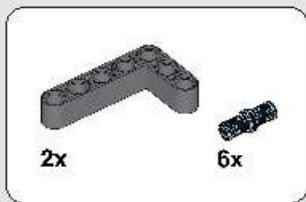

11

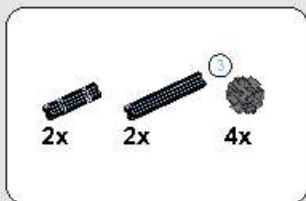
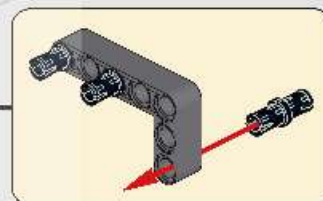
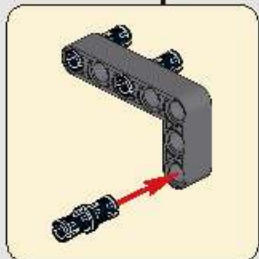
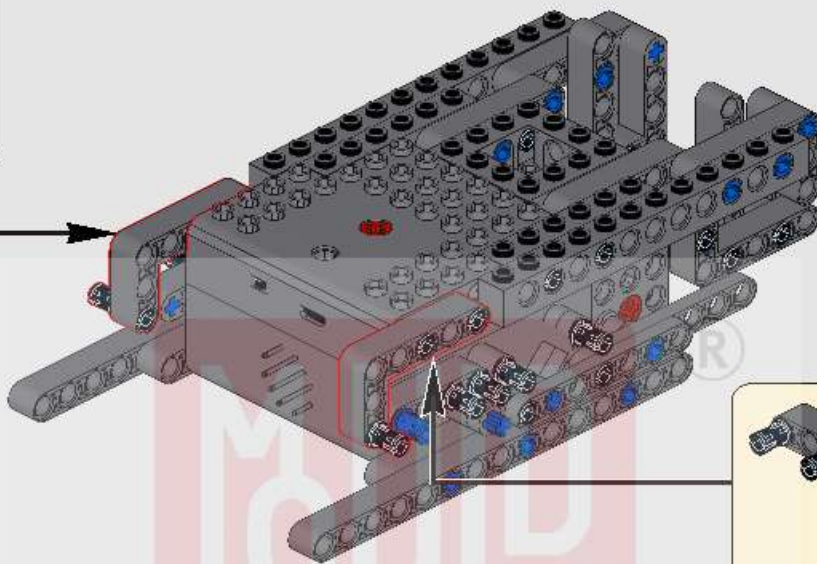

12

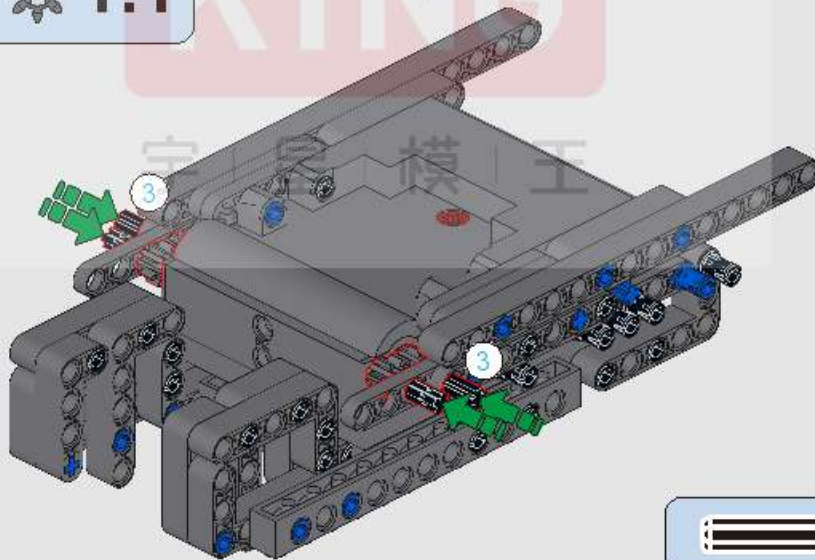

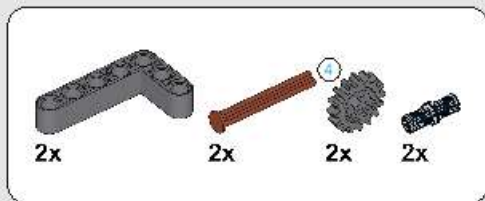

13

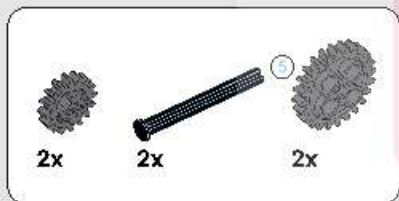
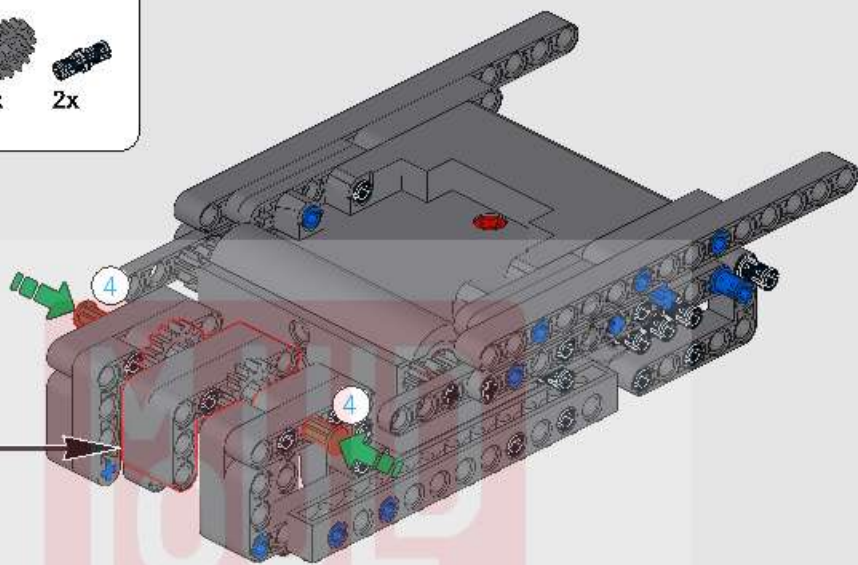
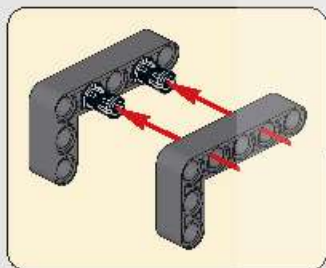

14

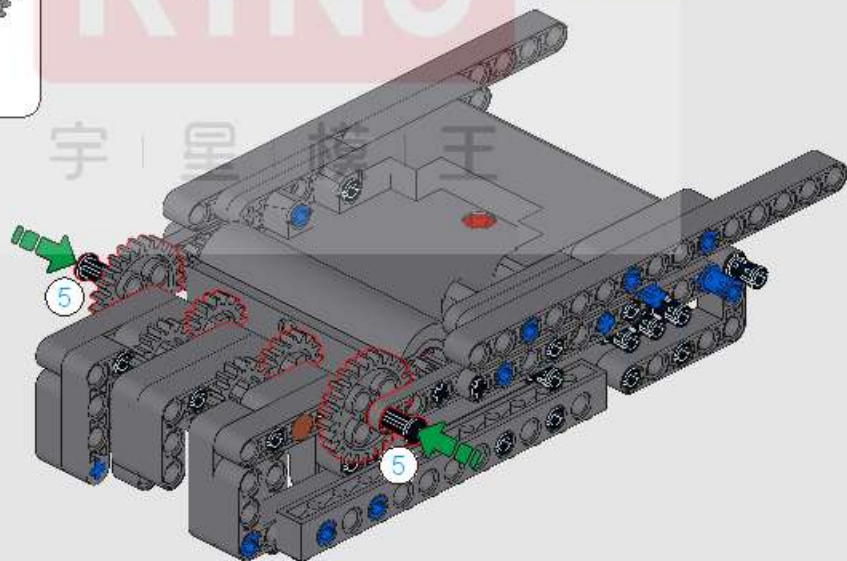

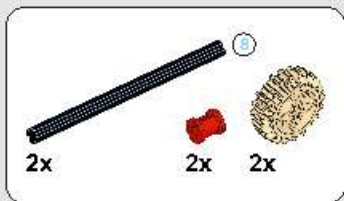

15

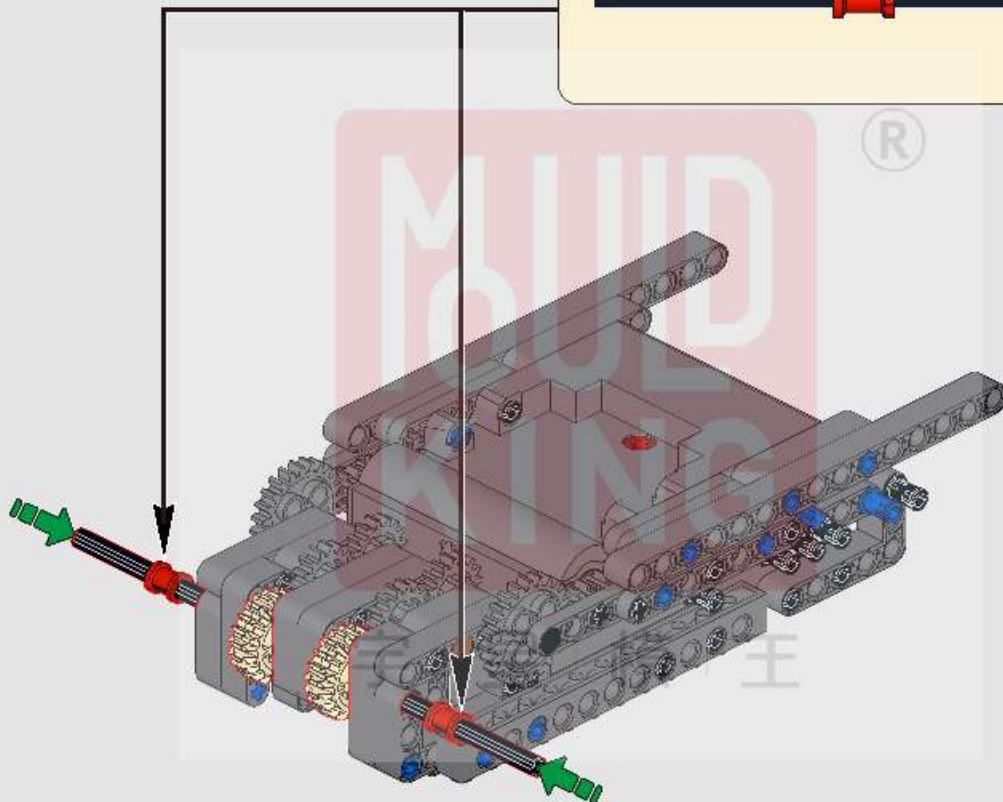
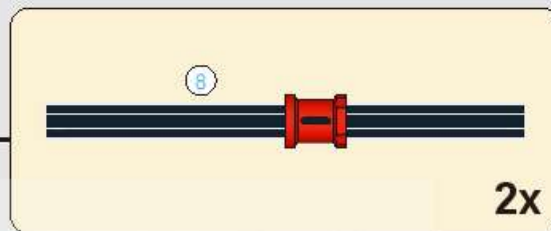

16

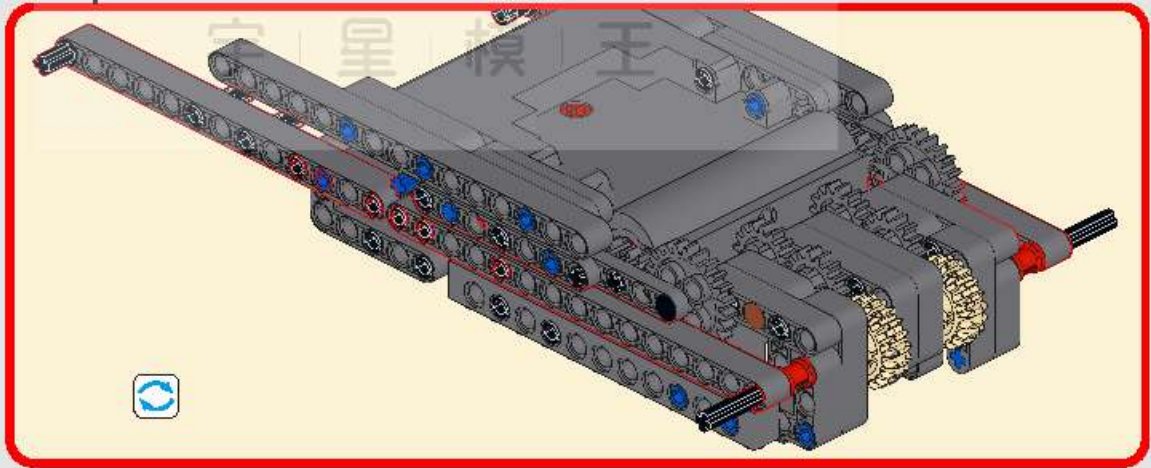
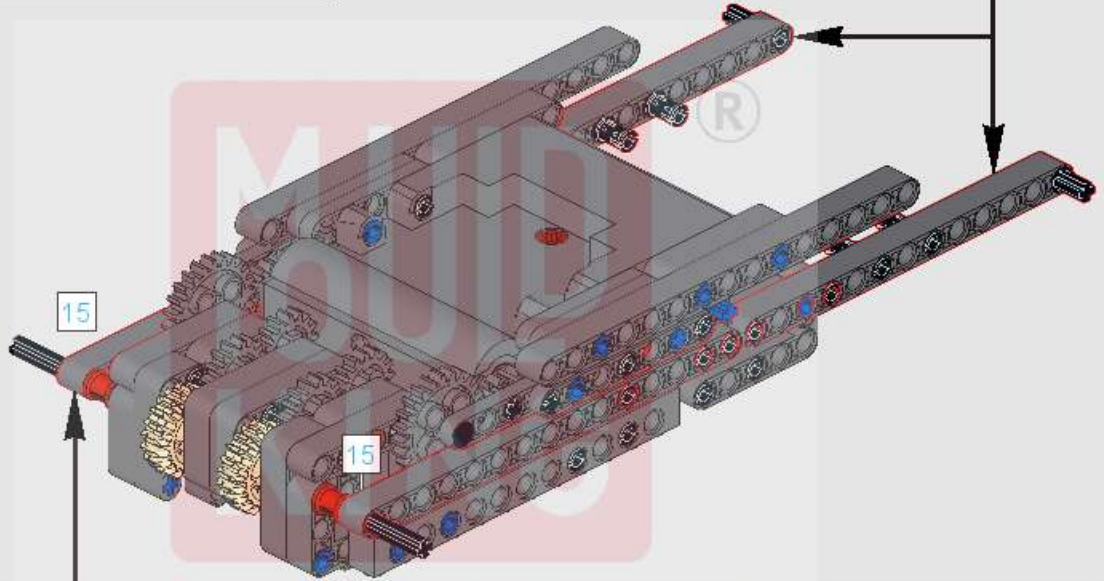
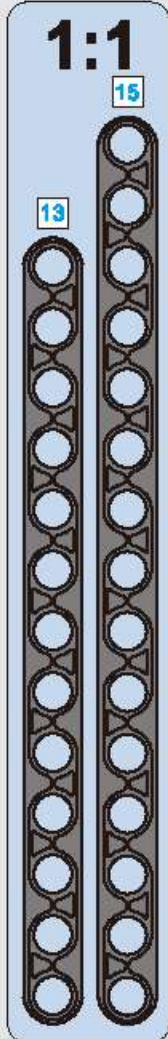
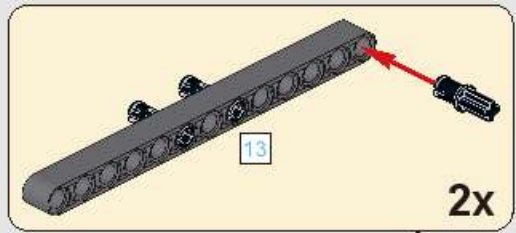
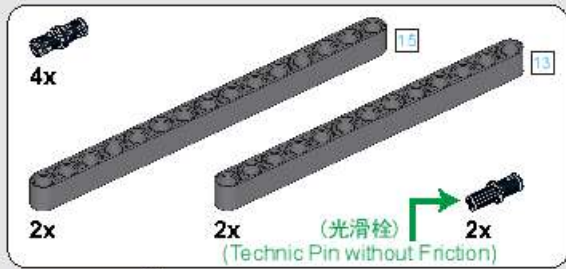

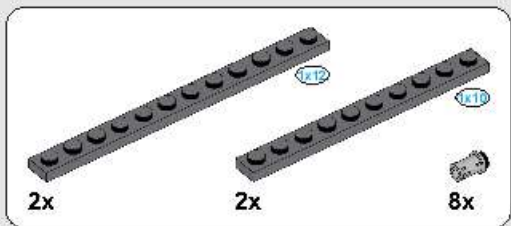

17

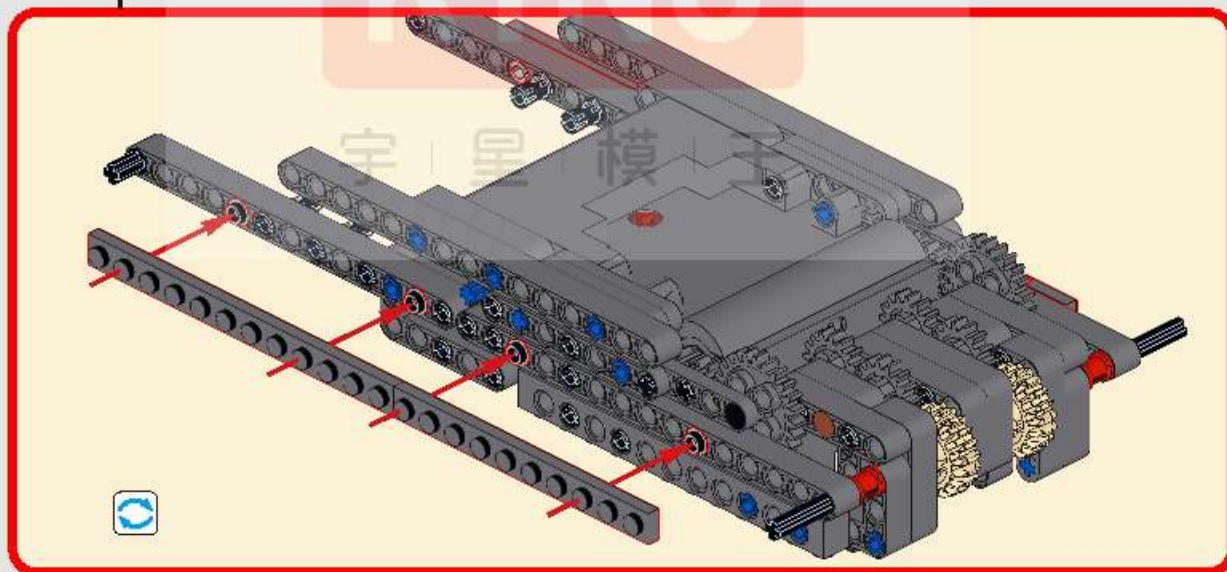
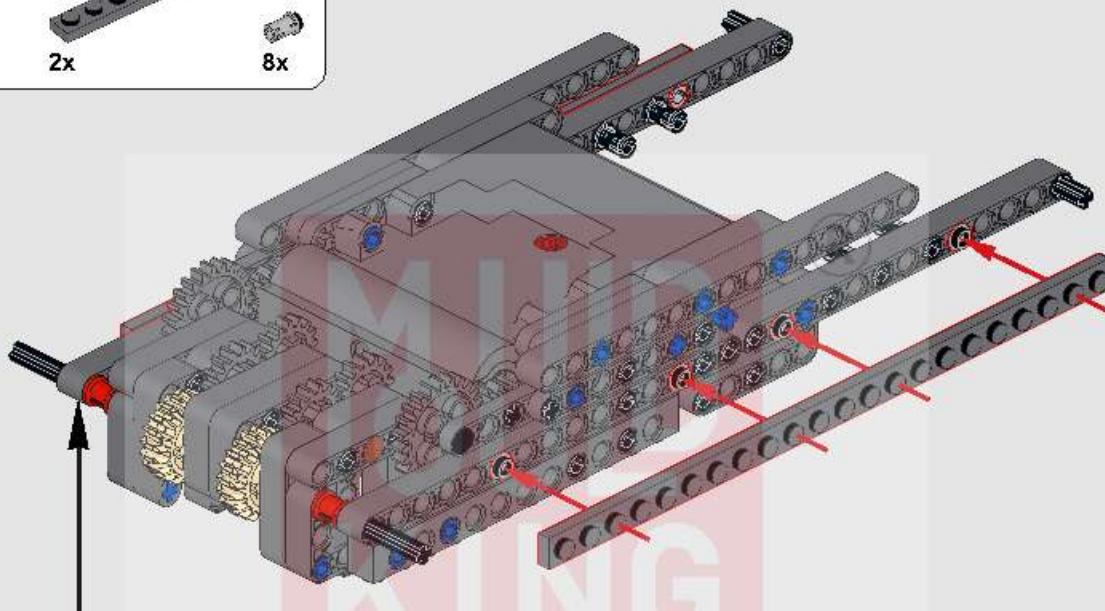

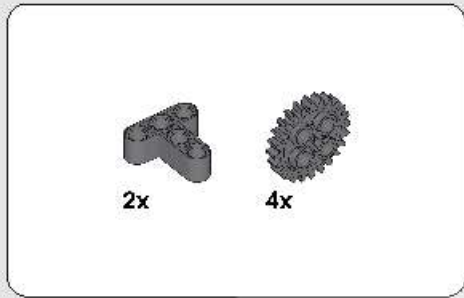

18

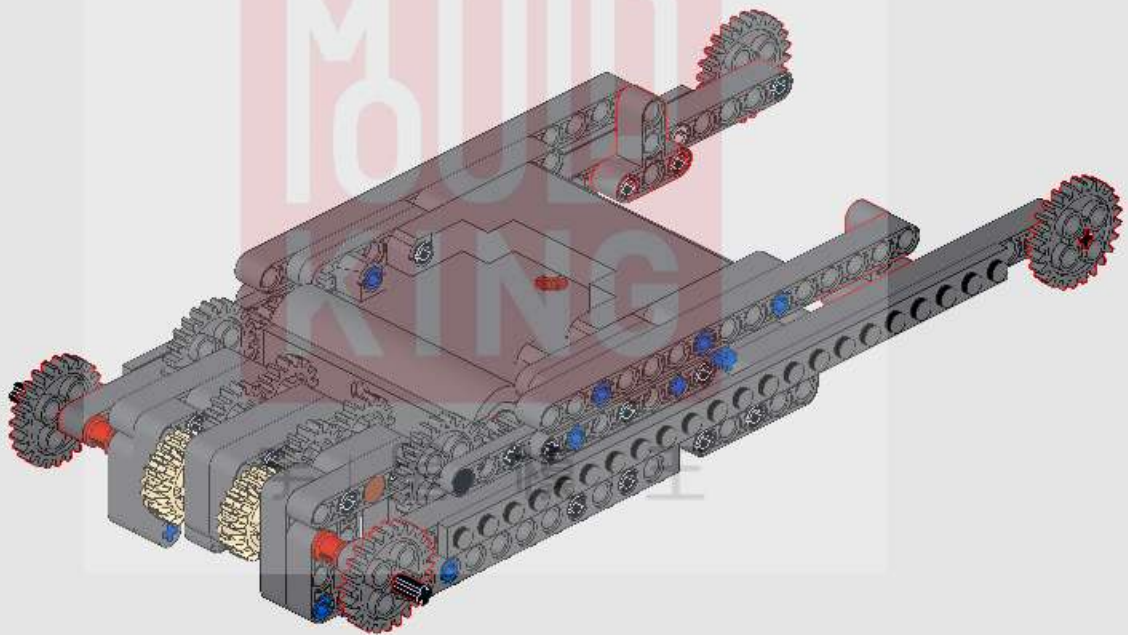

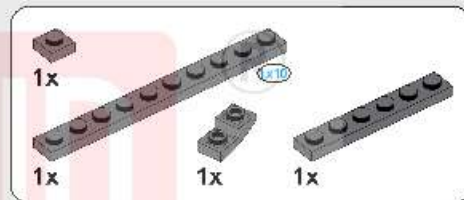
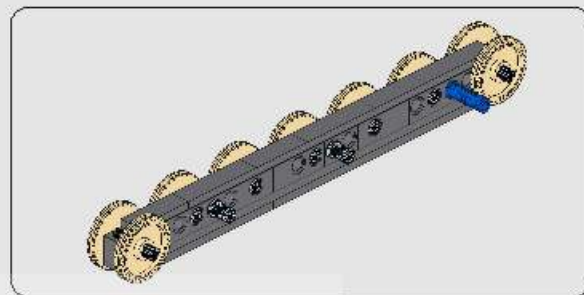

19

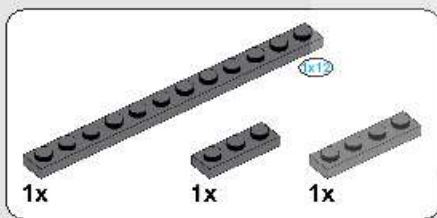
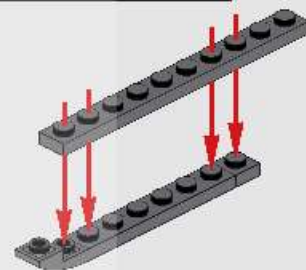

20

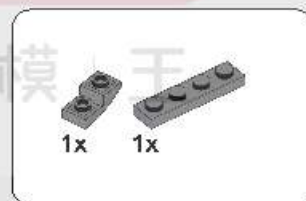
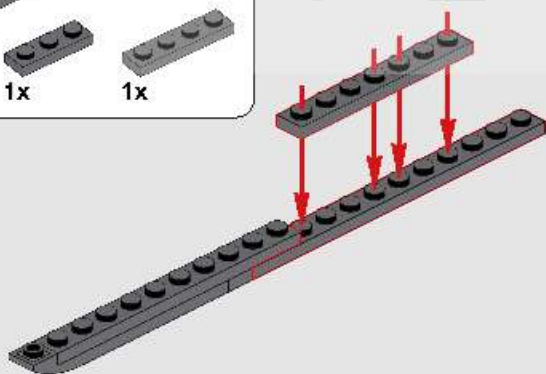

21

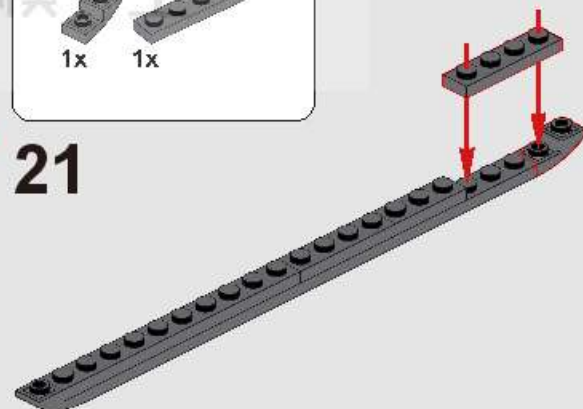

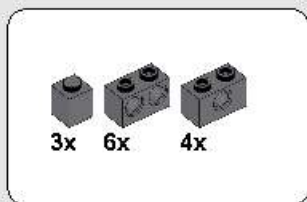

22



23

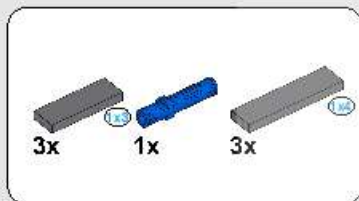
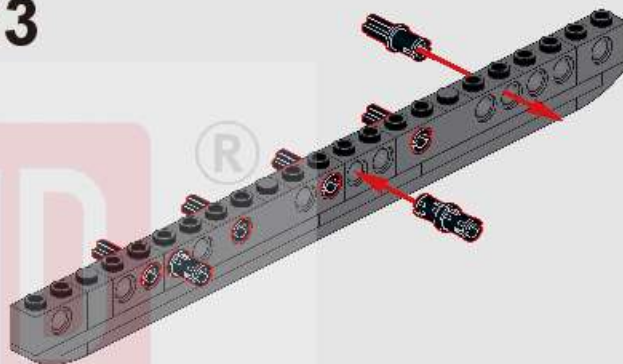

24

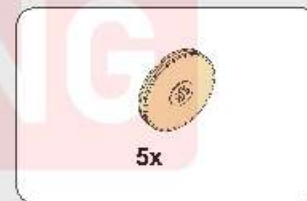
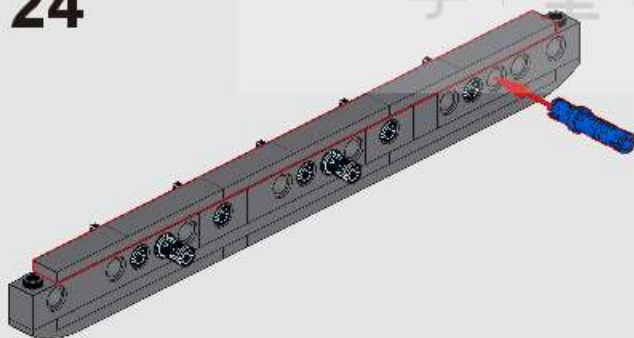

25

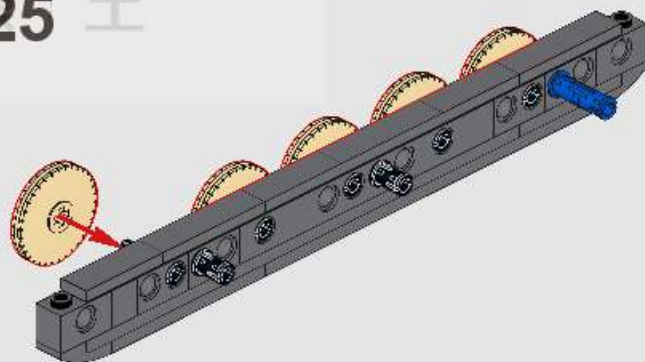

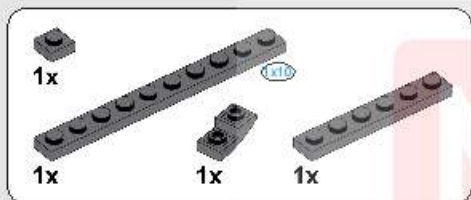
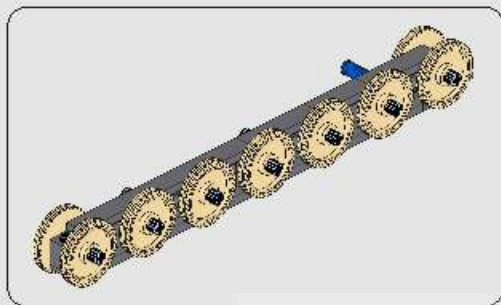

28

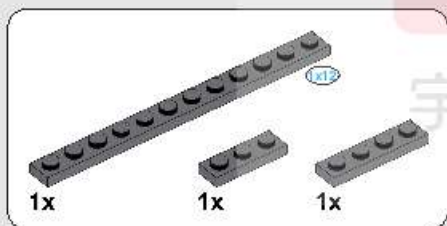
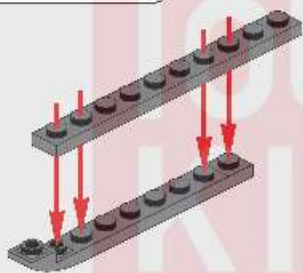

29

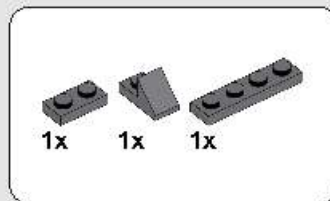
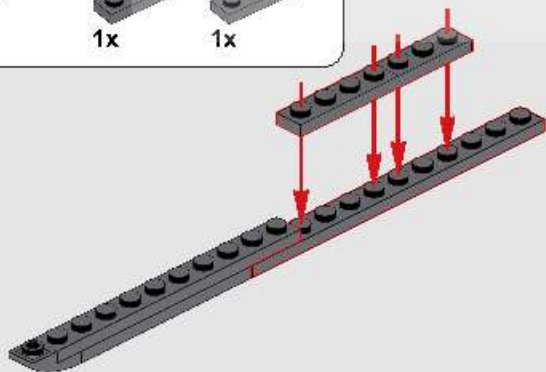

30

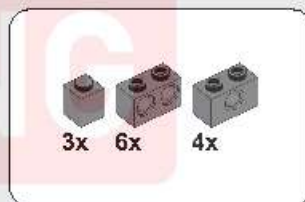
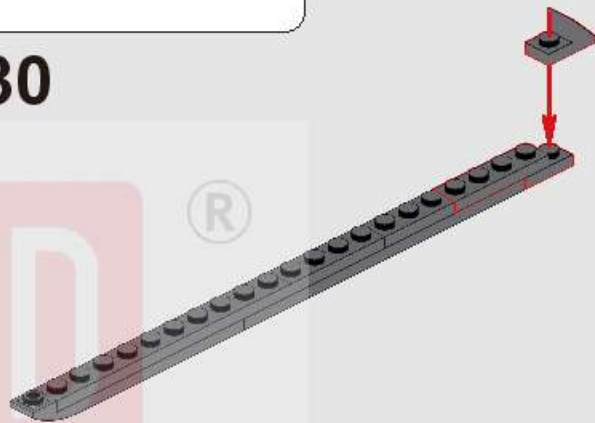

31

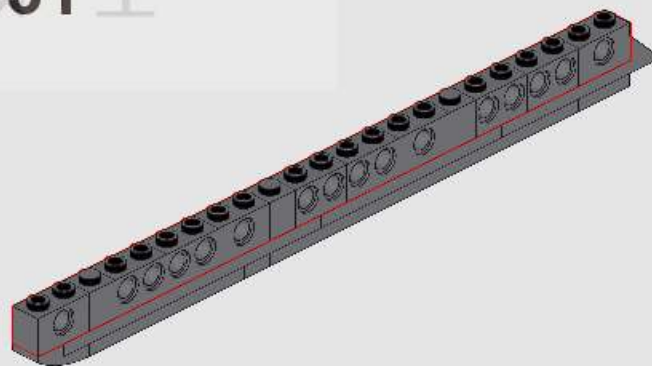

2x 5x
 (光滑栓)
 (Technic Pin without Friction)

3x 1x 3x

32

33

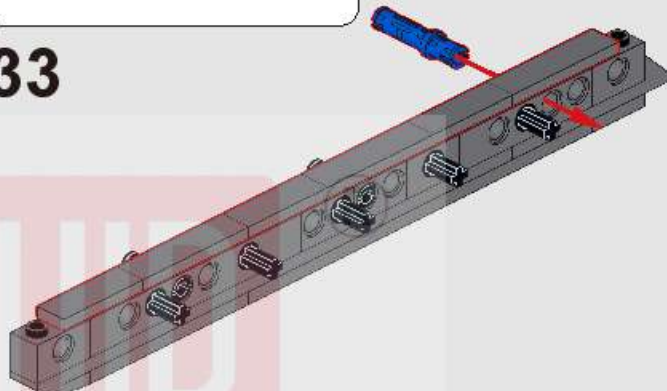
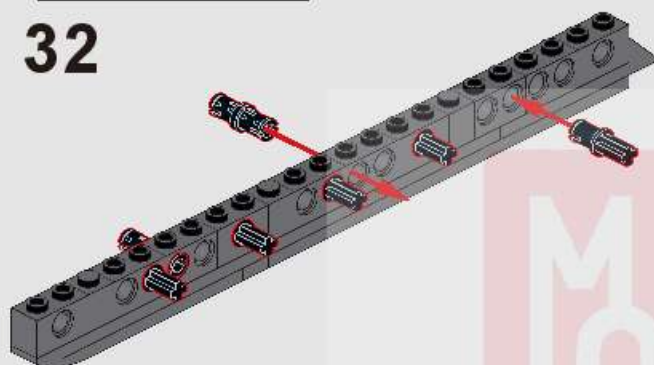

34

35

5x

2x 4x

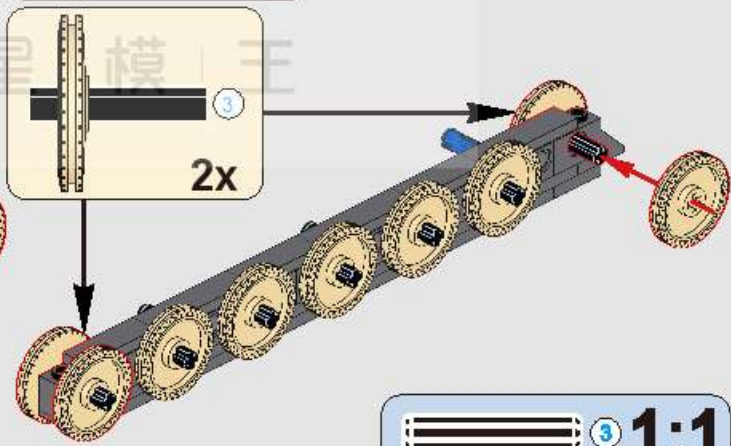
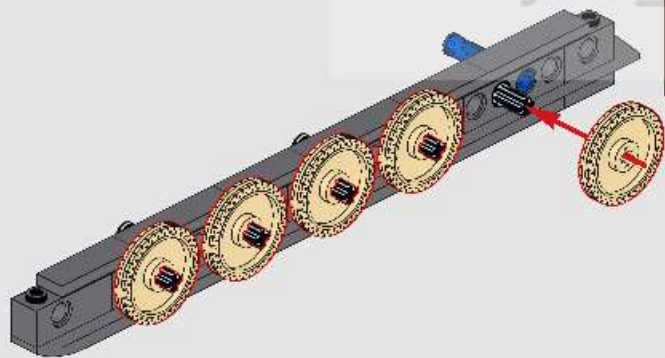

3 1:1

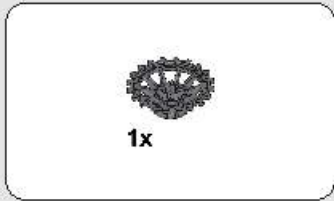

36

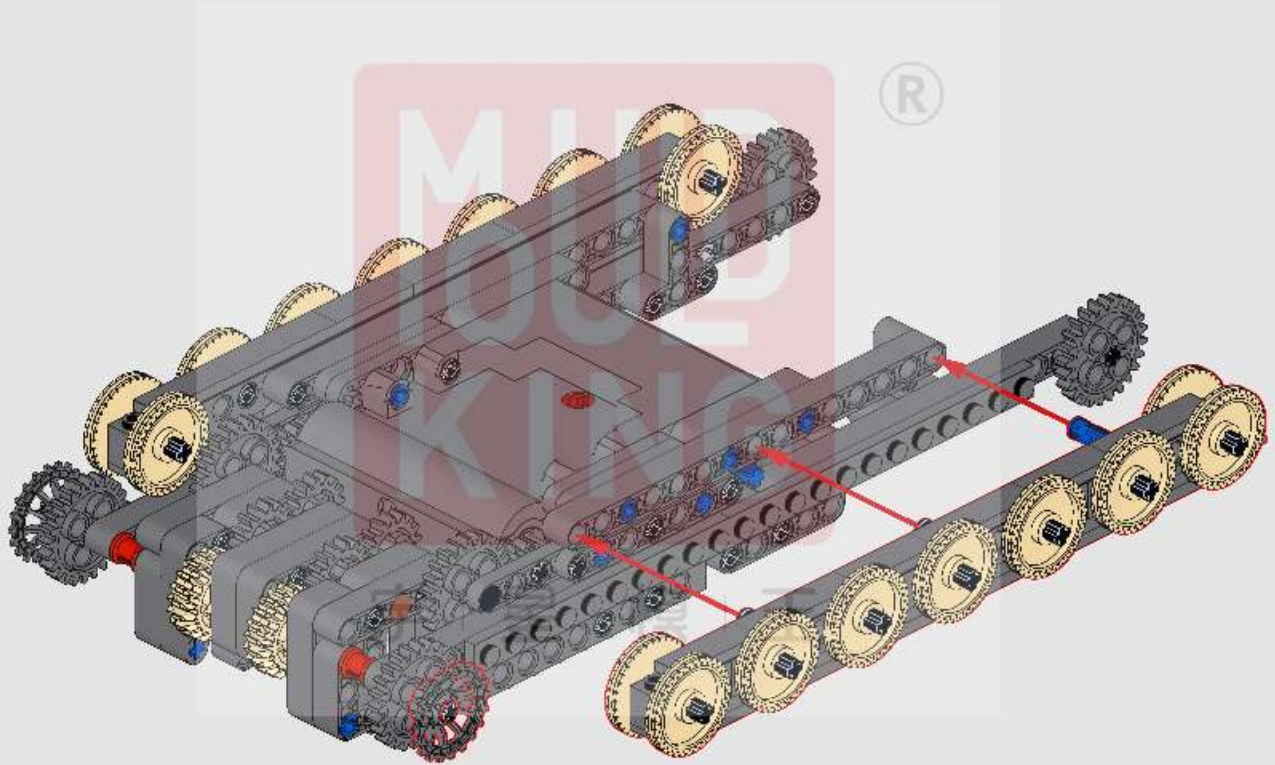



162x

37

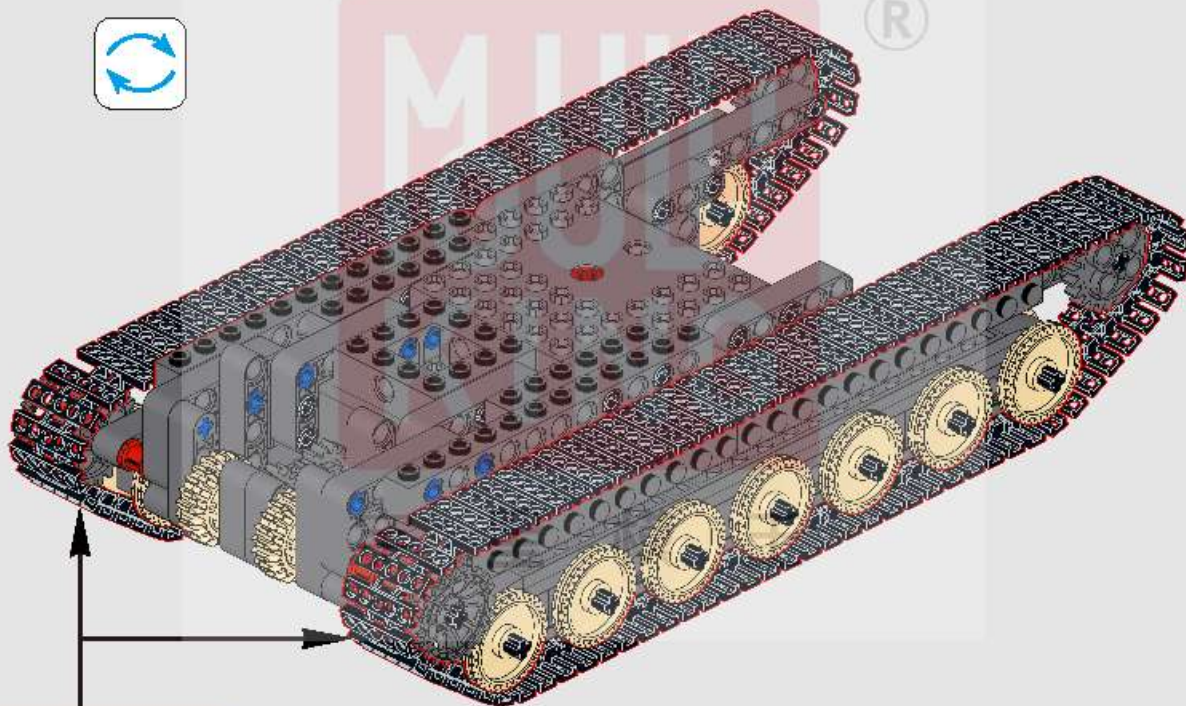

81x

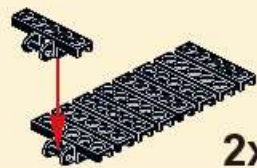

2x

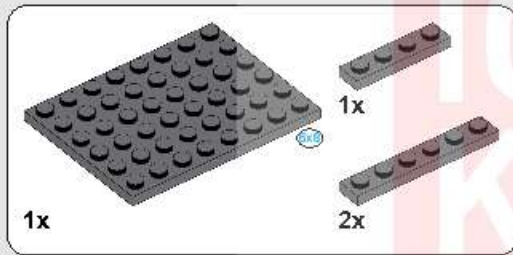
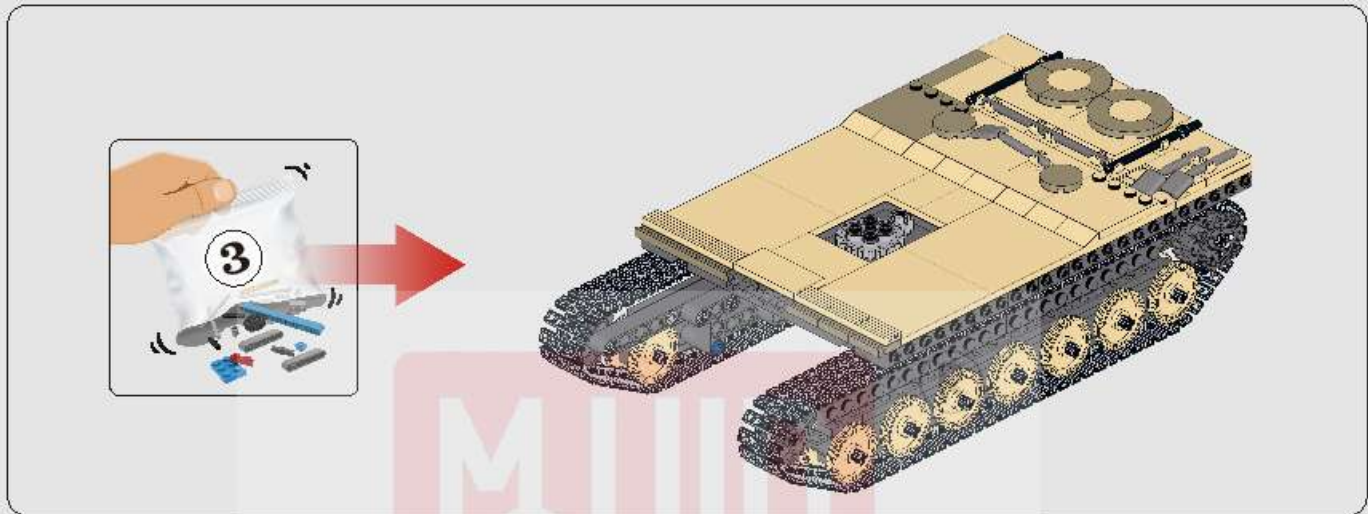

38



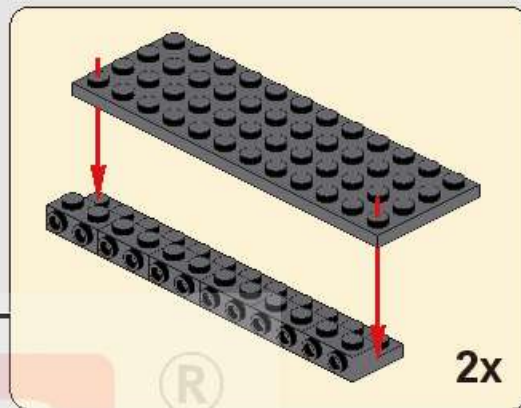
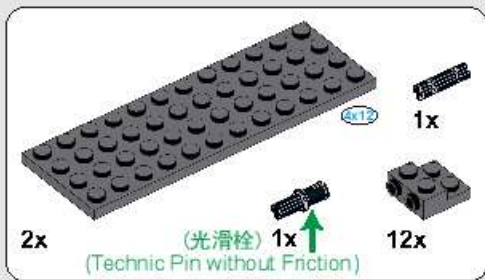

39

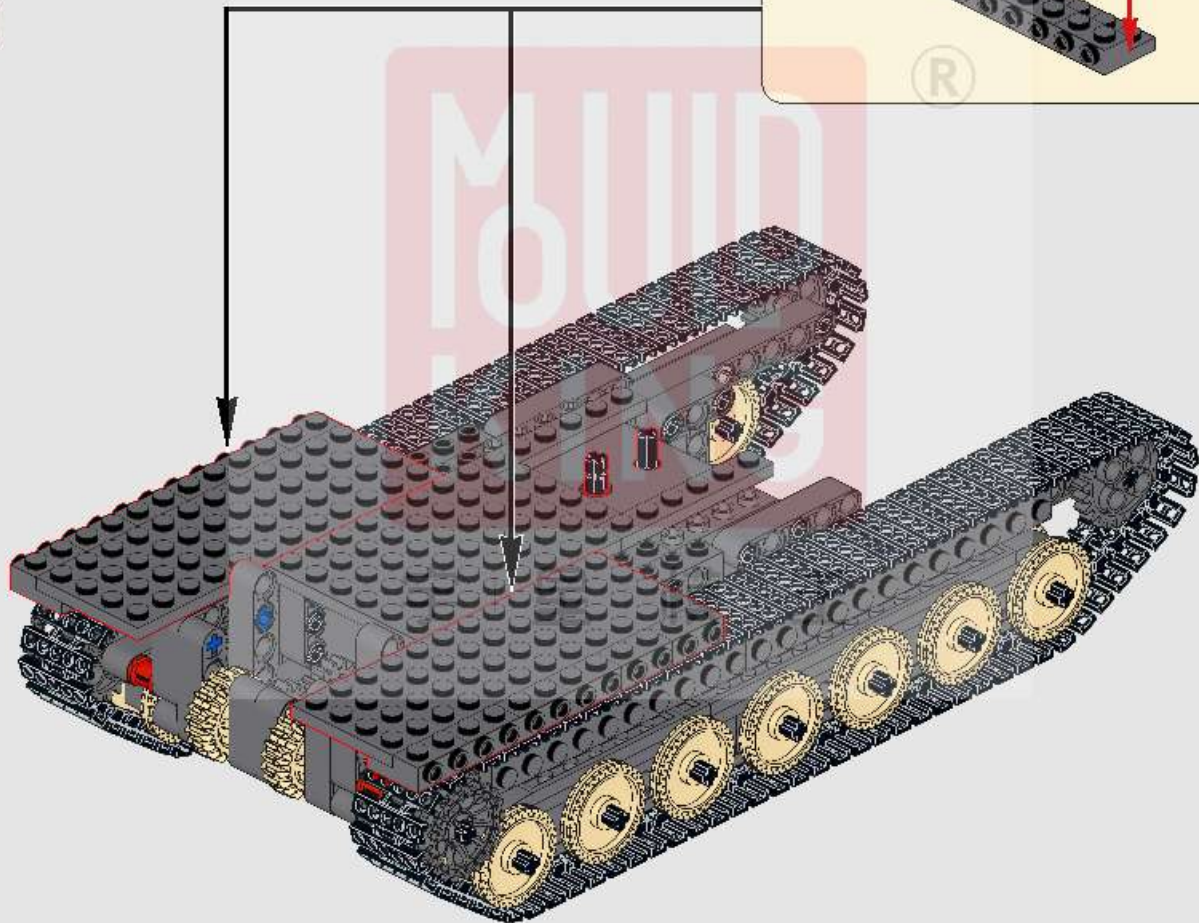

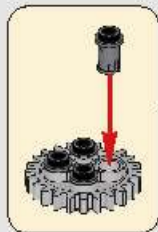
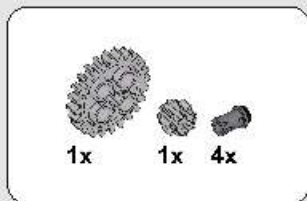

40

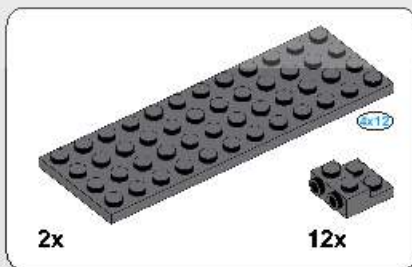
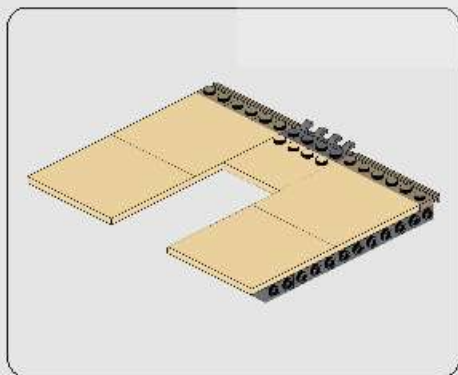
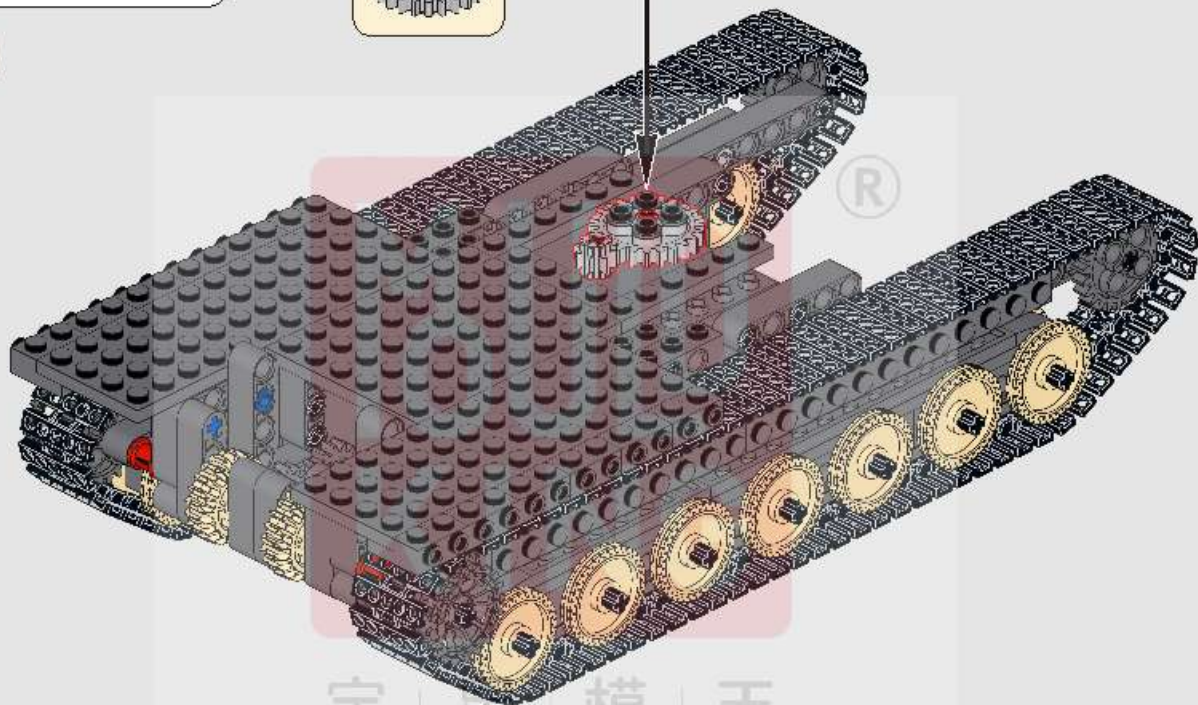

41

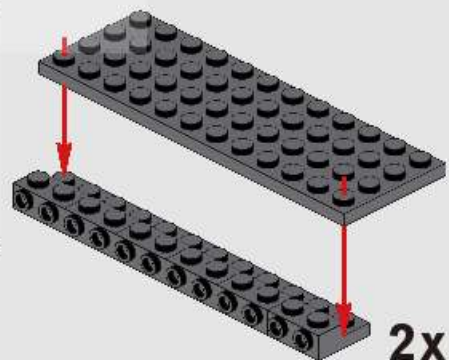

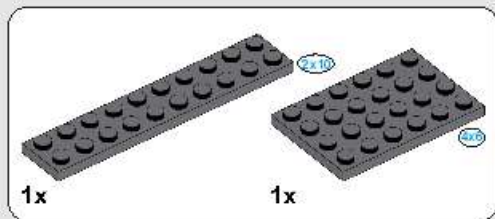

42

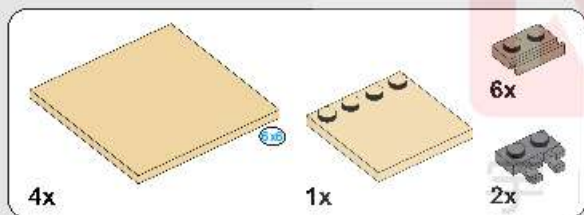
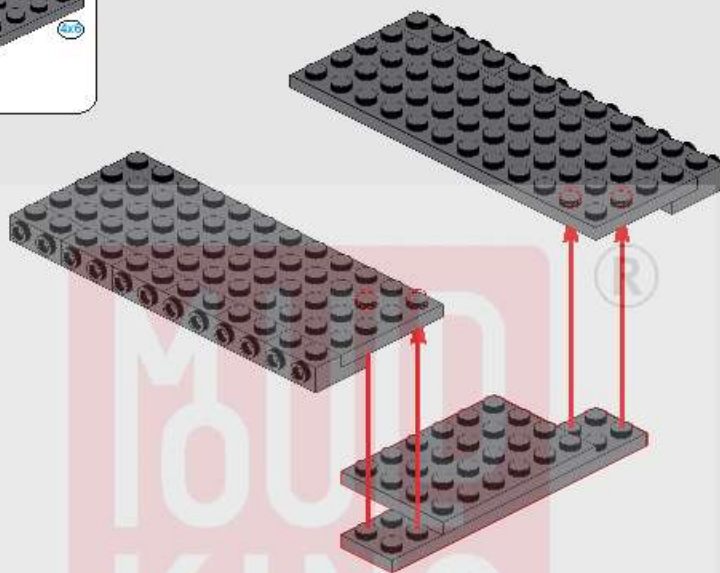

43

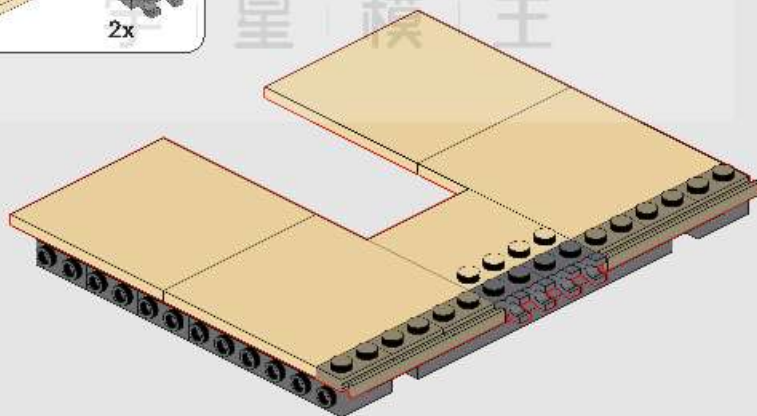

44

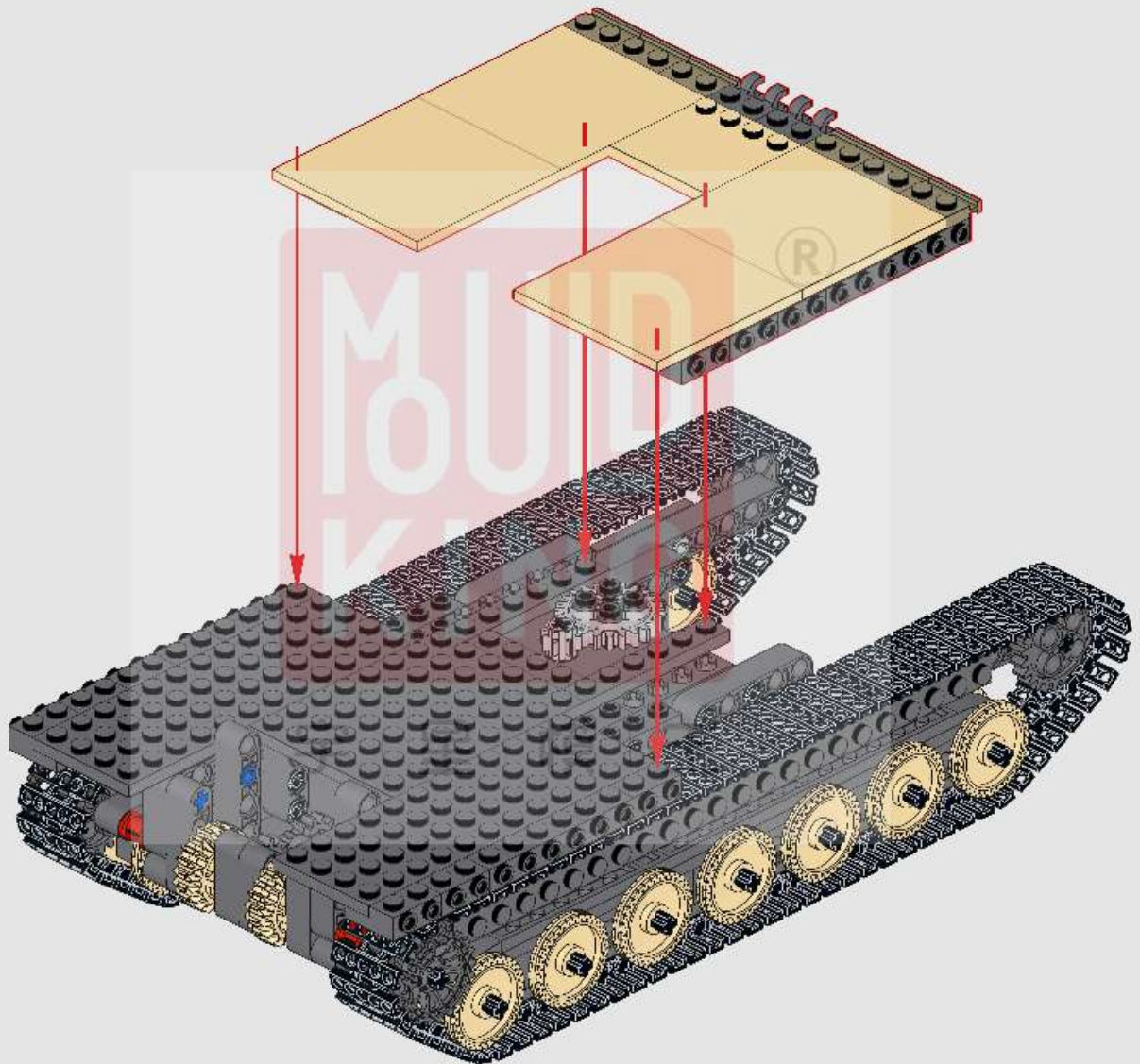

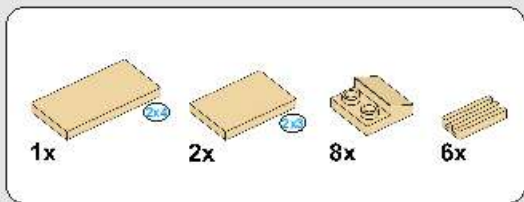

45

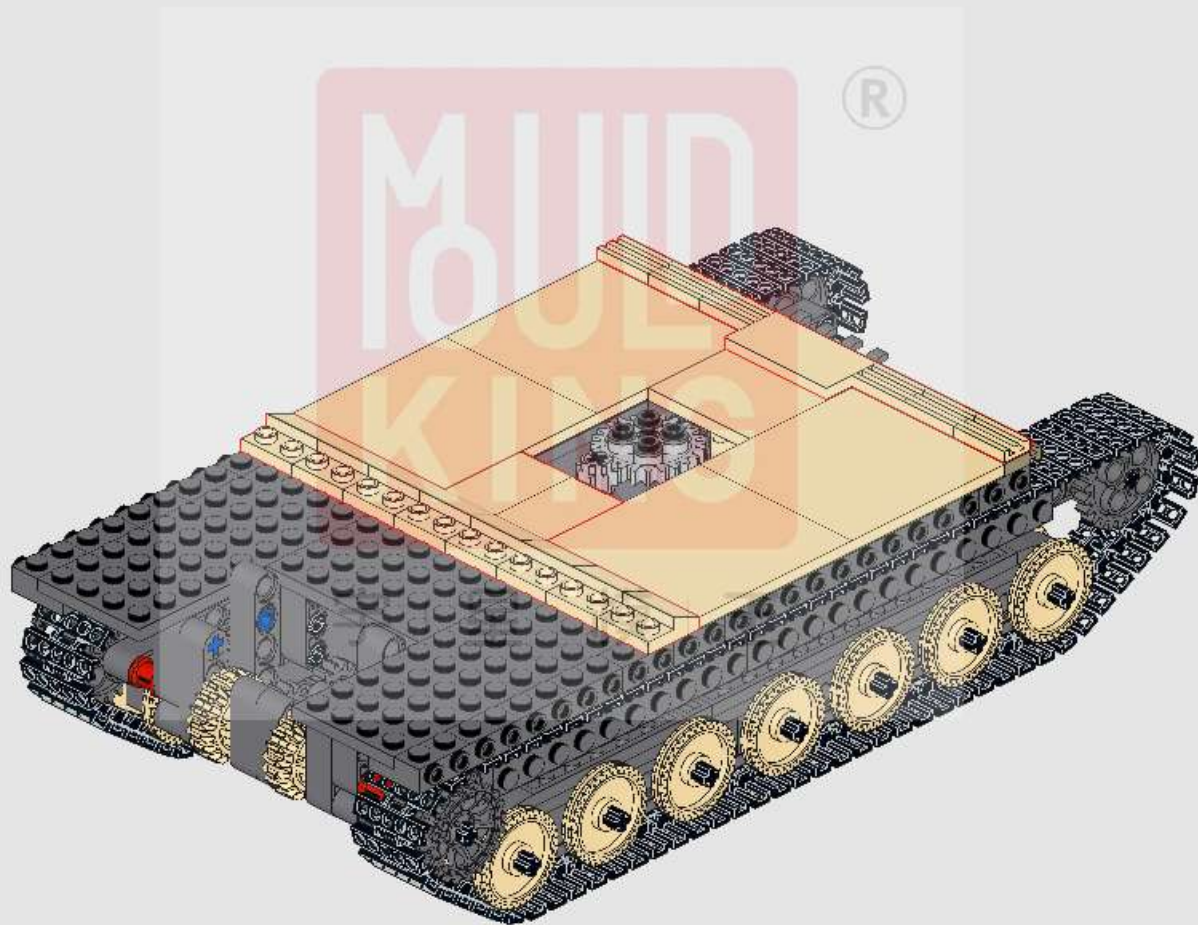

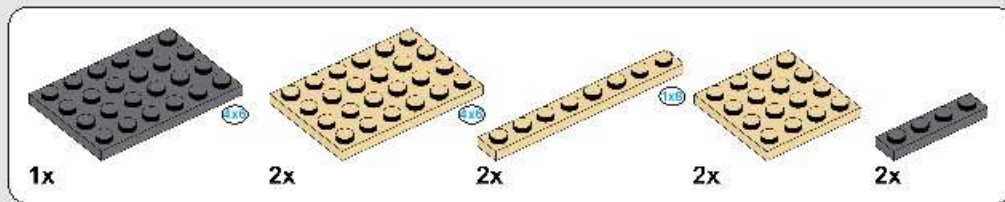

46

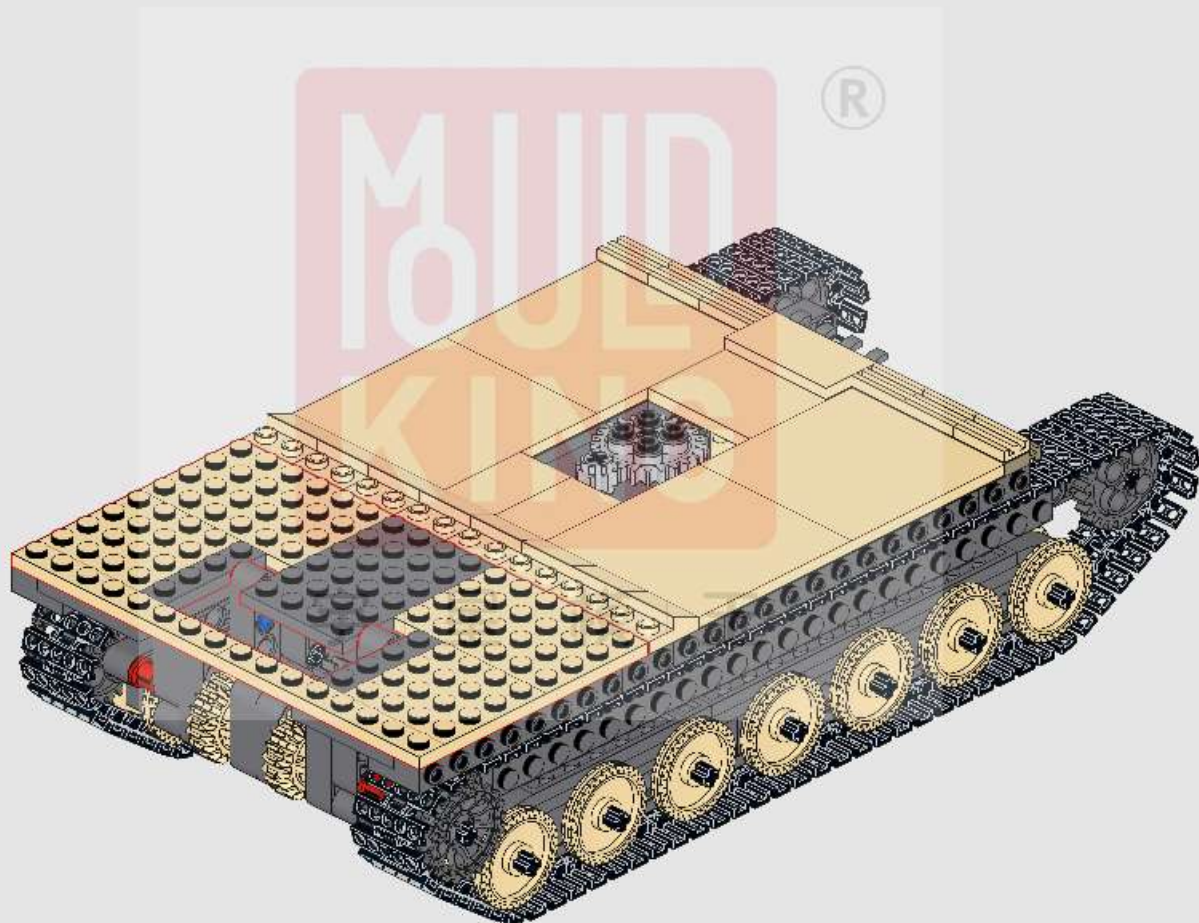

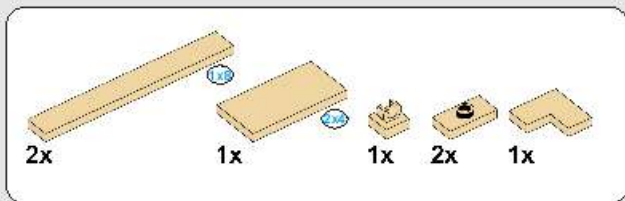

47



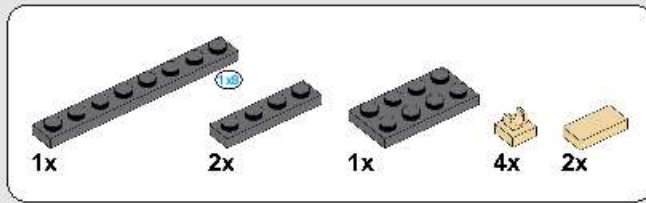

48

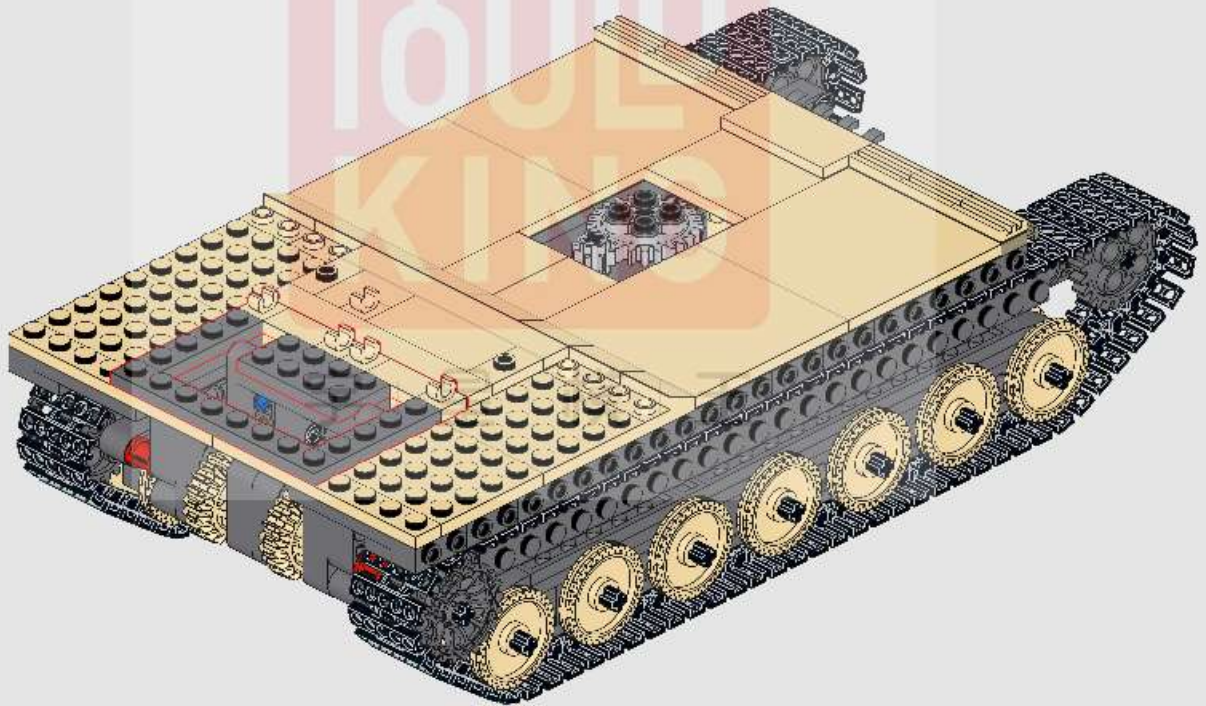

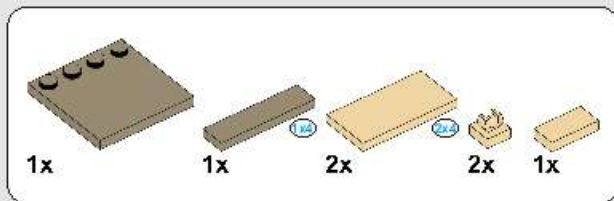

50

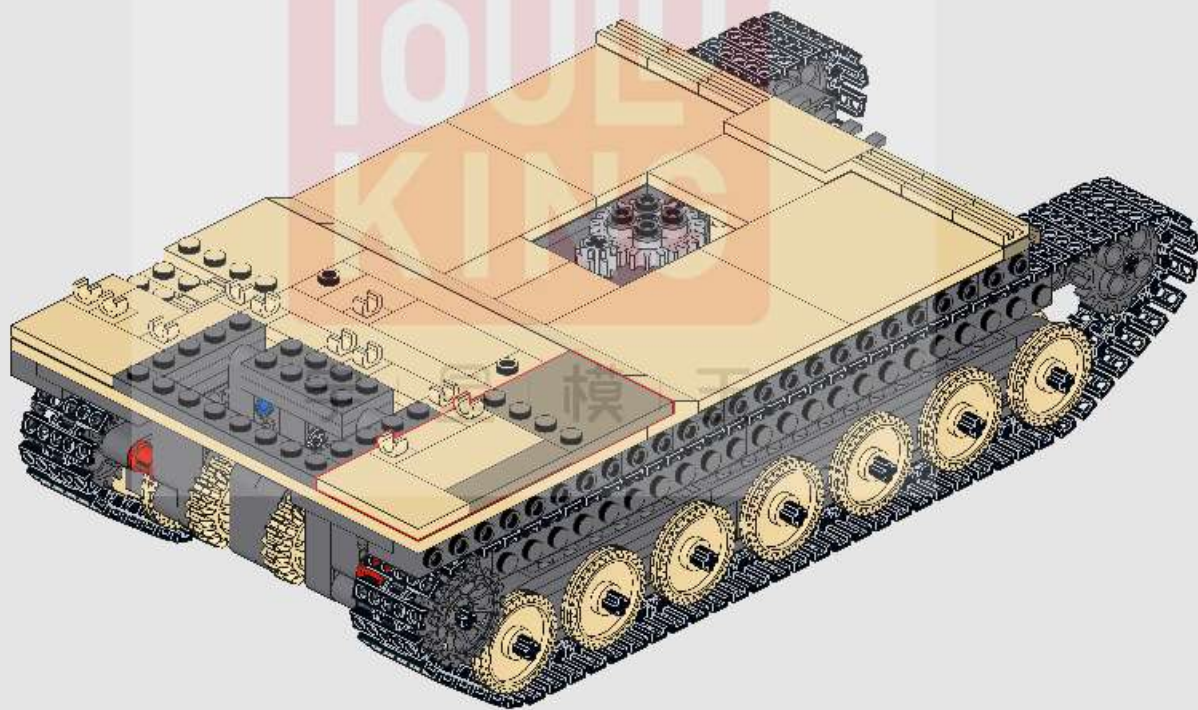

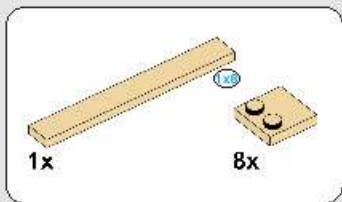

51

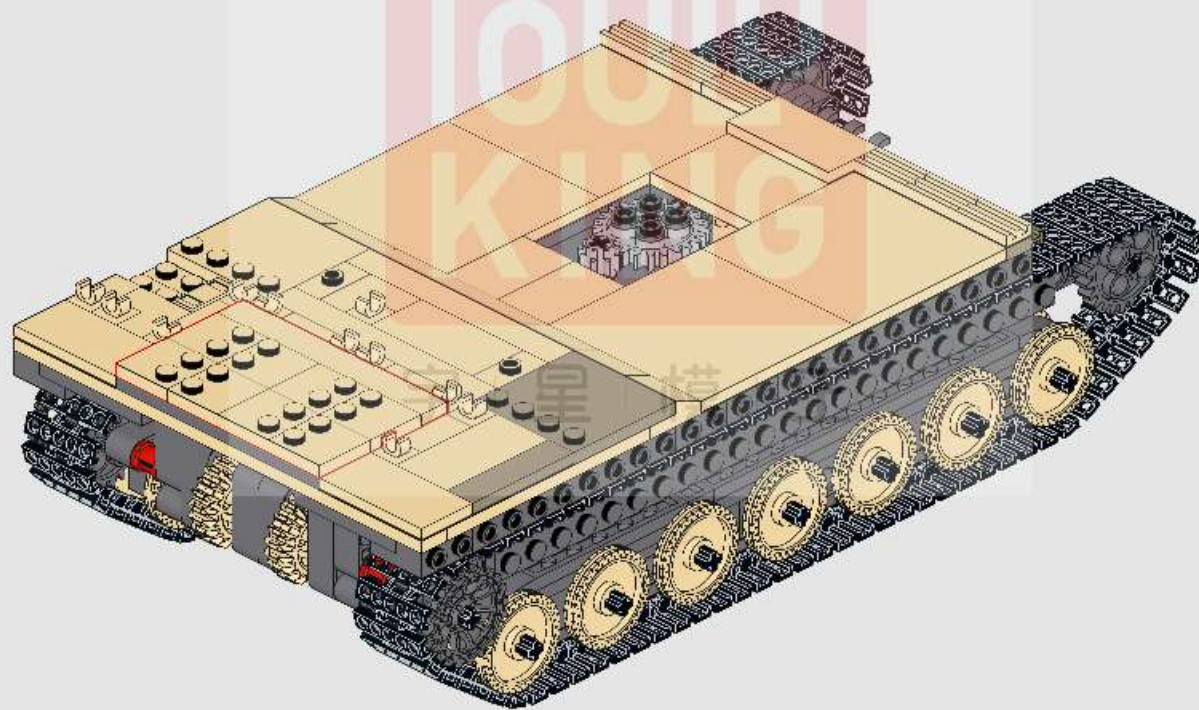

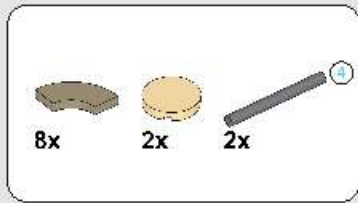

52

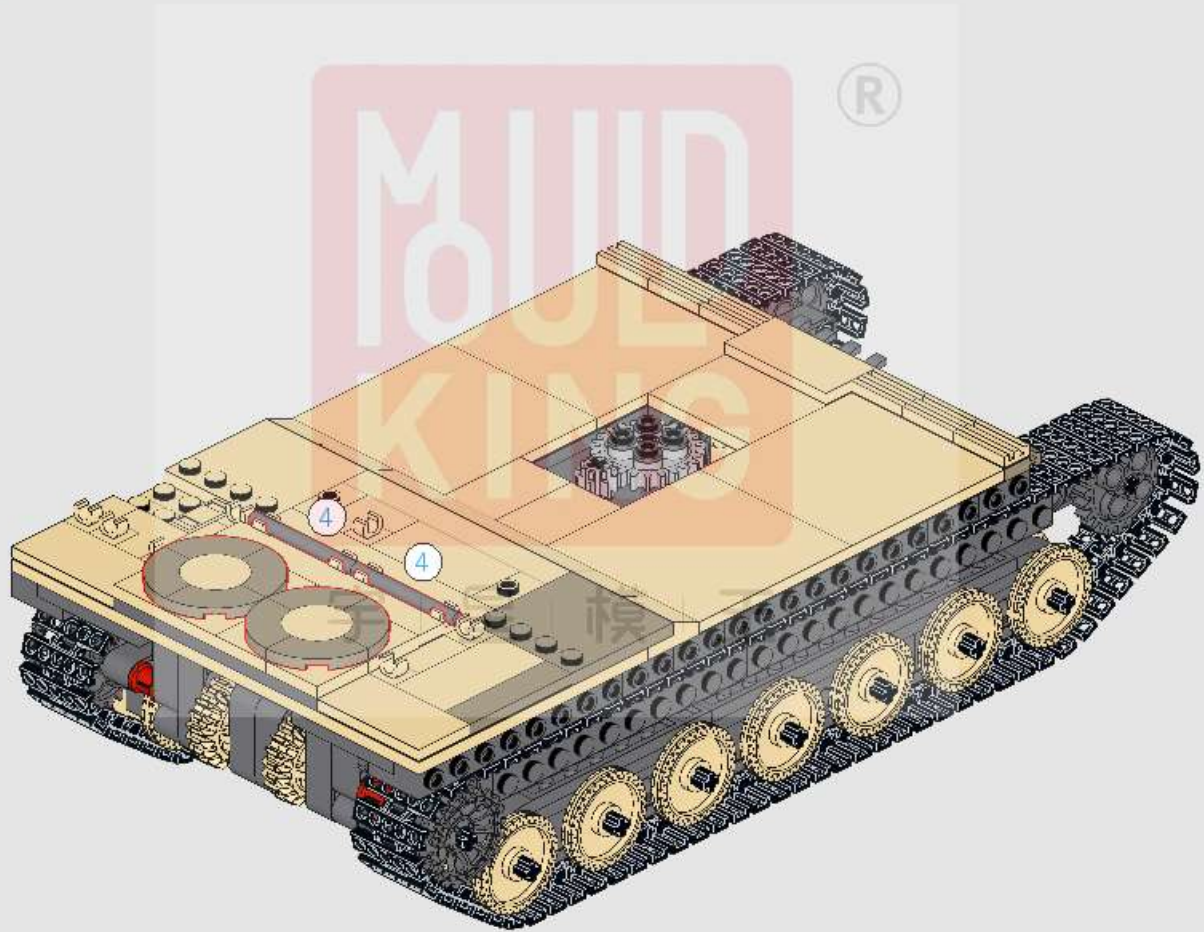

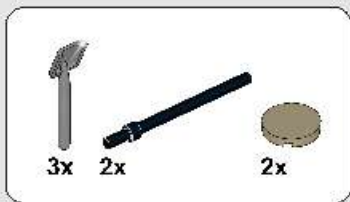

53

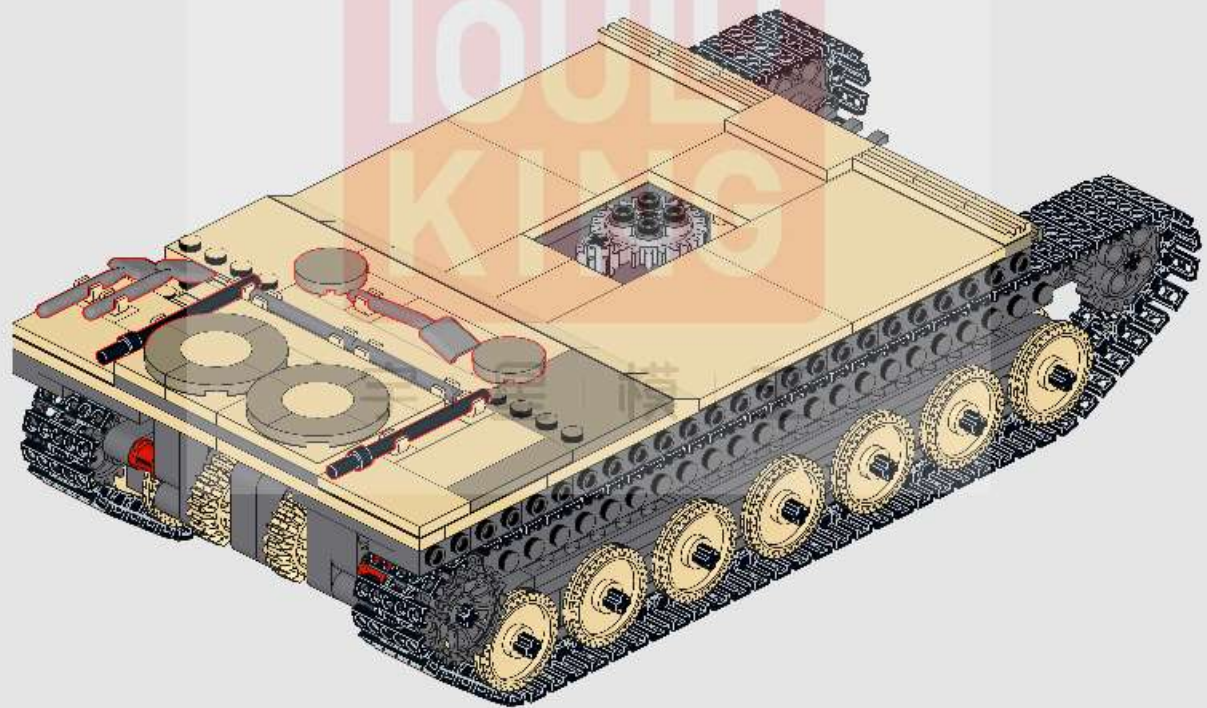

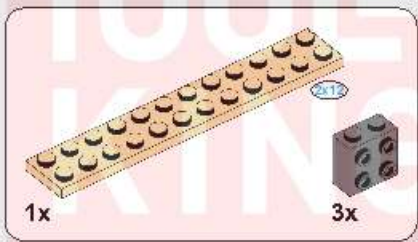
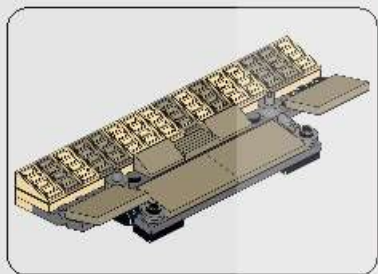
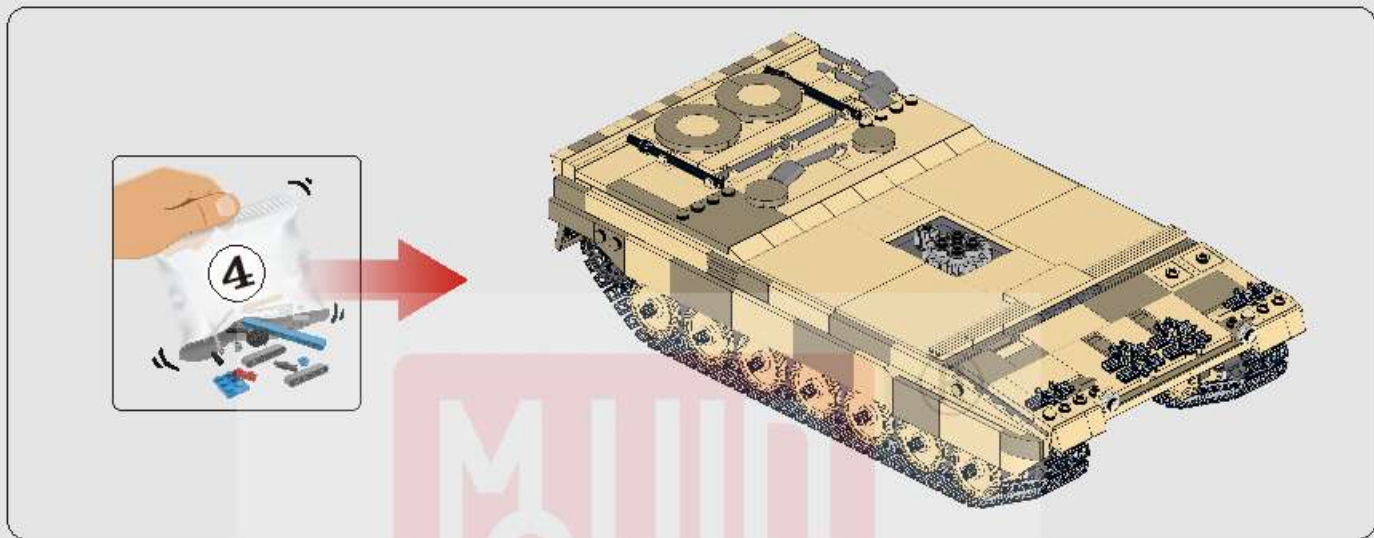

54

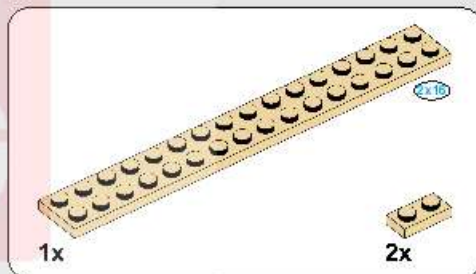

55

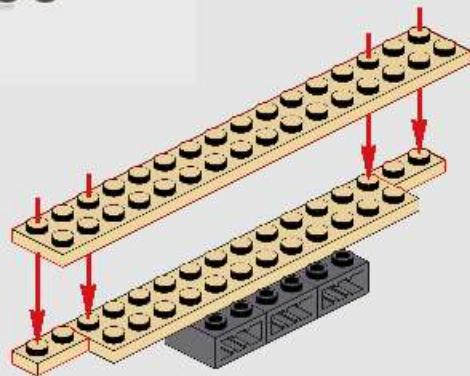
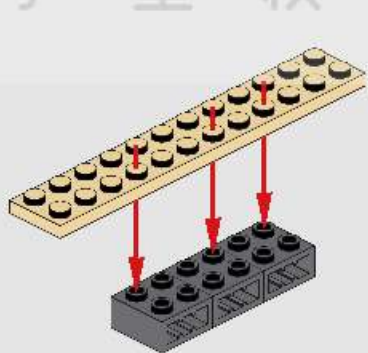

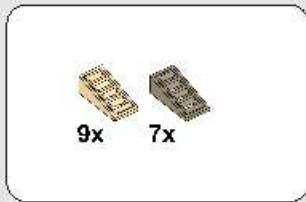

56

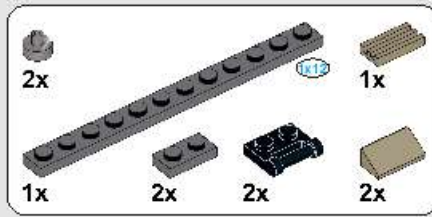
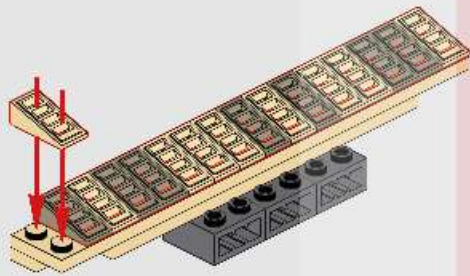

57

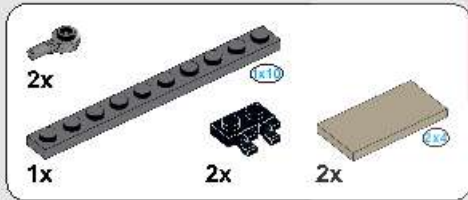
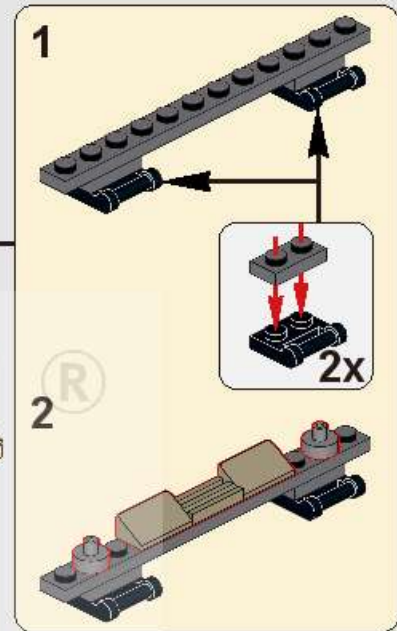
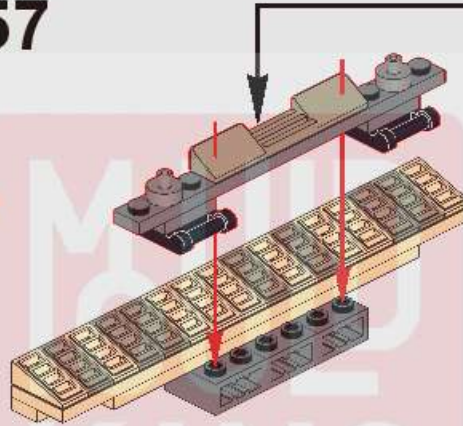

58

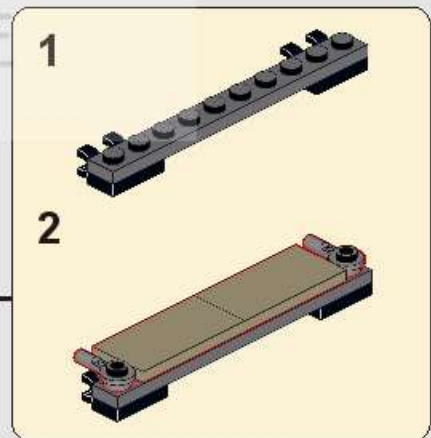
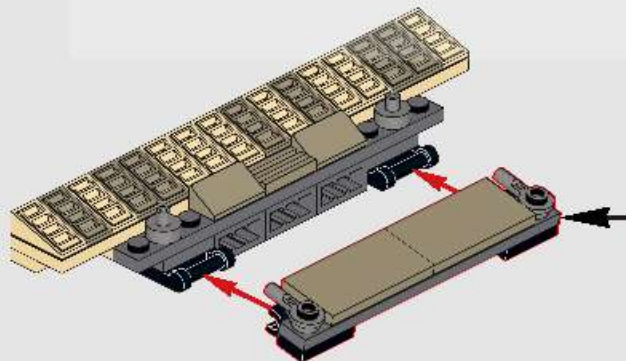

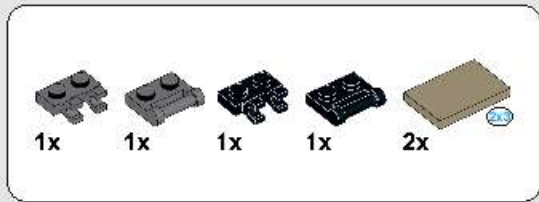

59

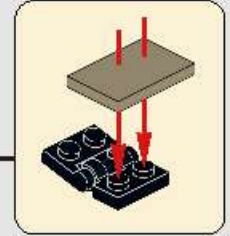
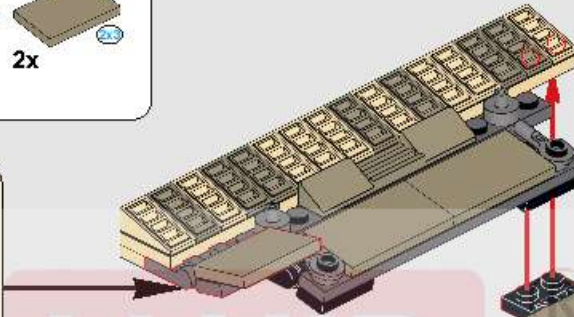
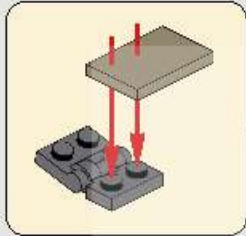

60

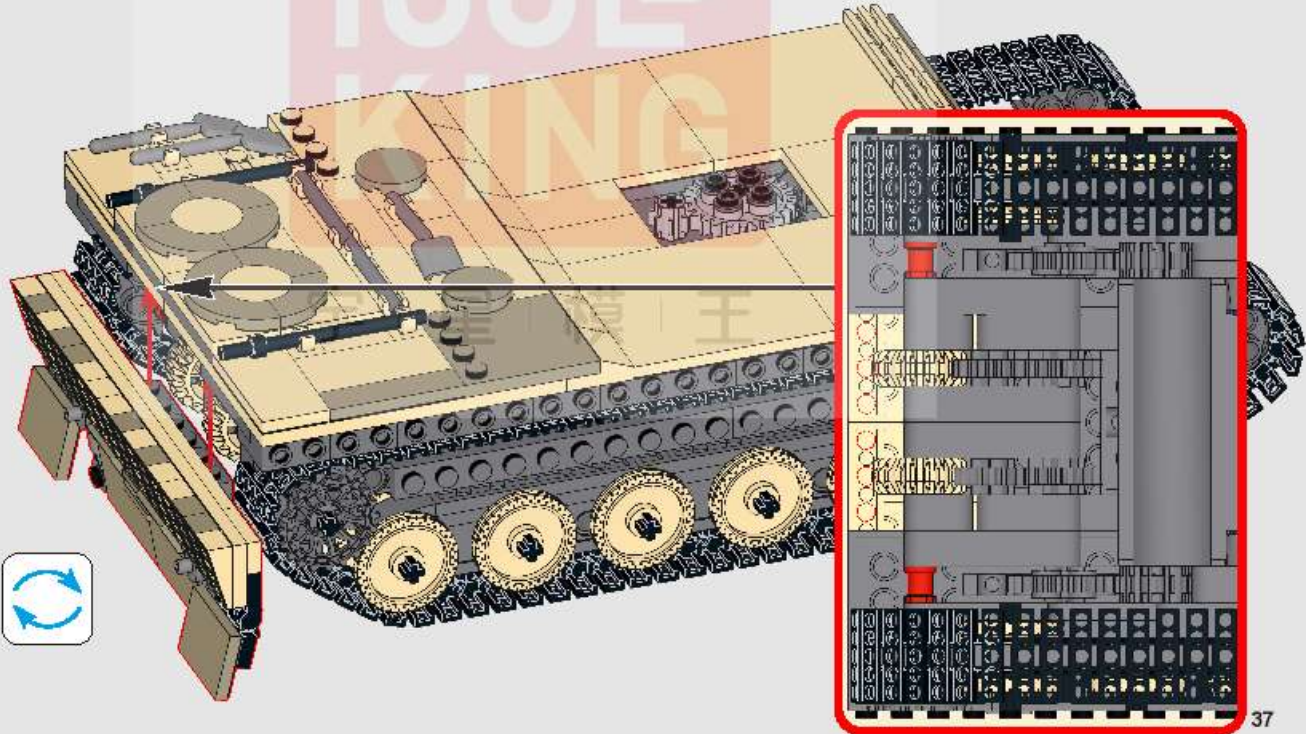

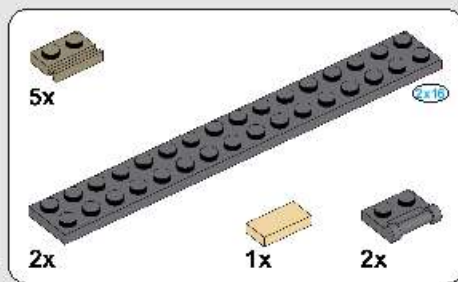
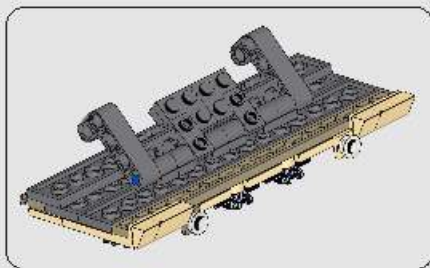

61

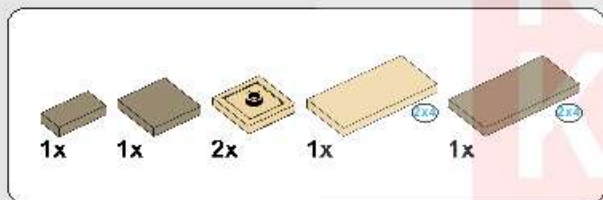
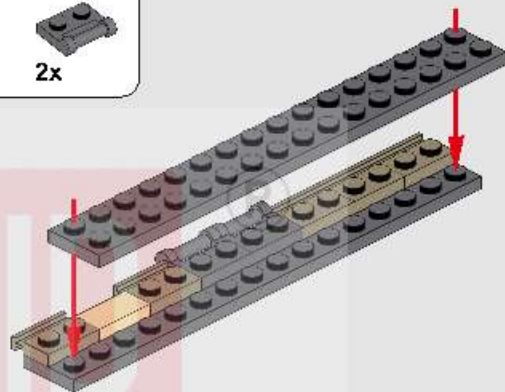

62

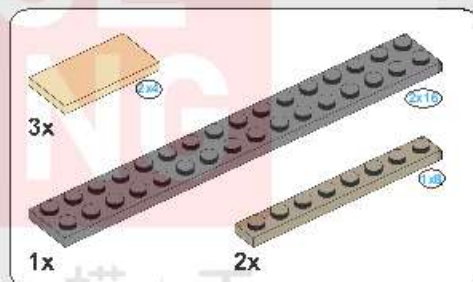

63

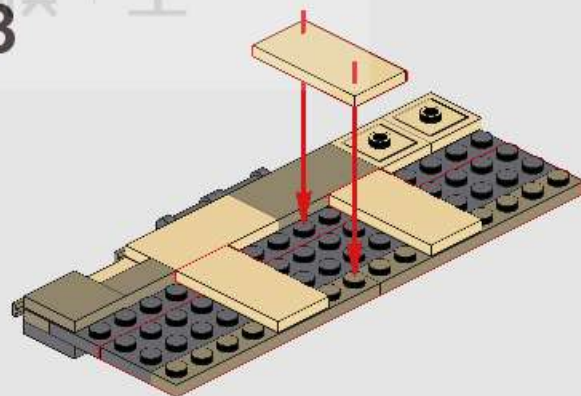
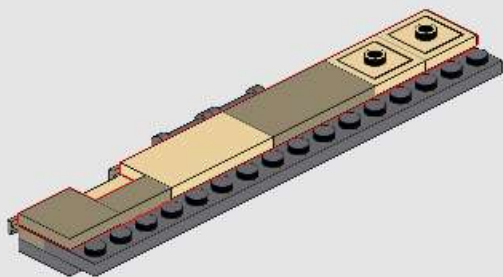

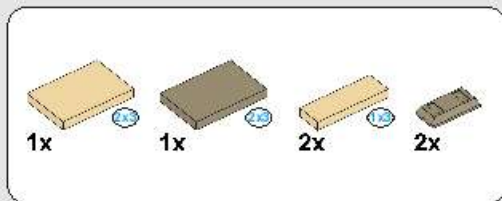

64

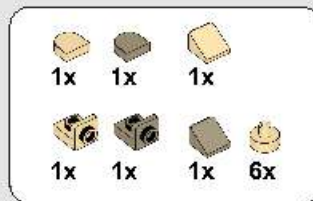

65

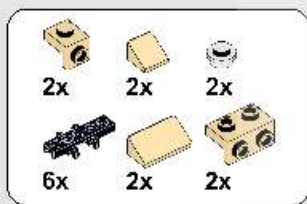
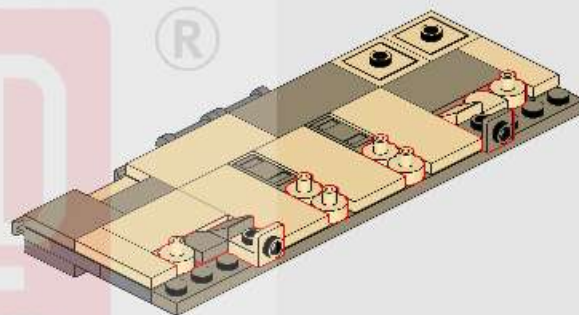
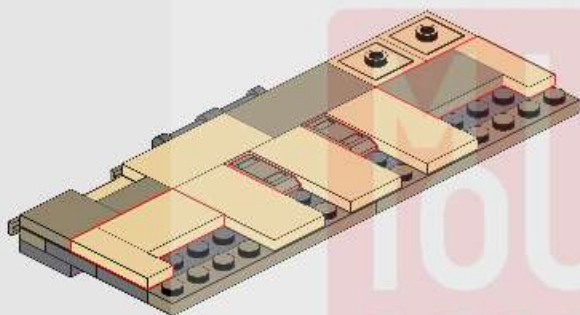

66

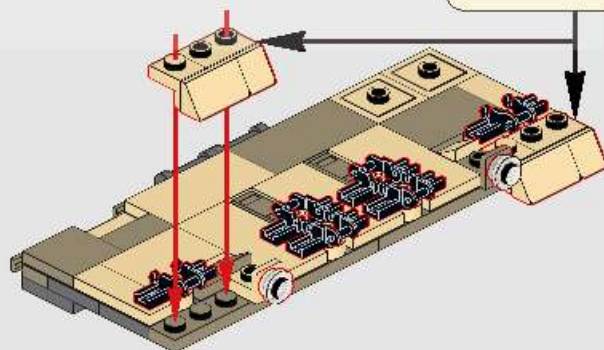
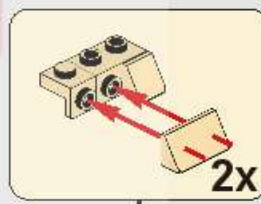

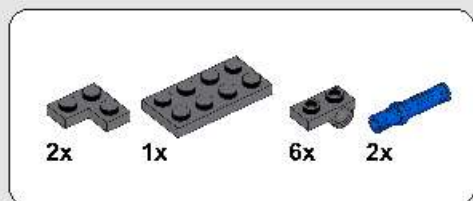

67

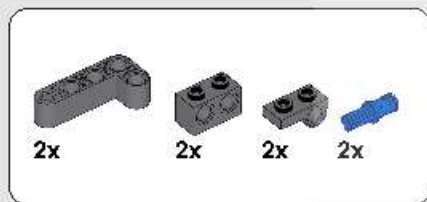
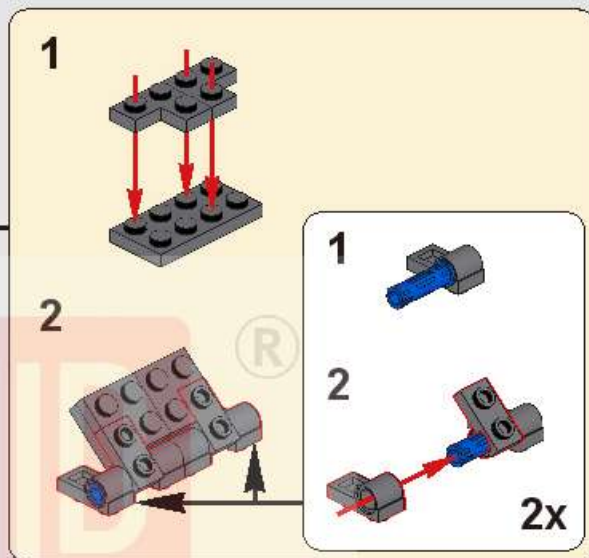
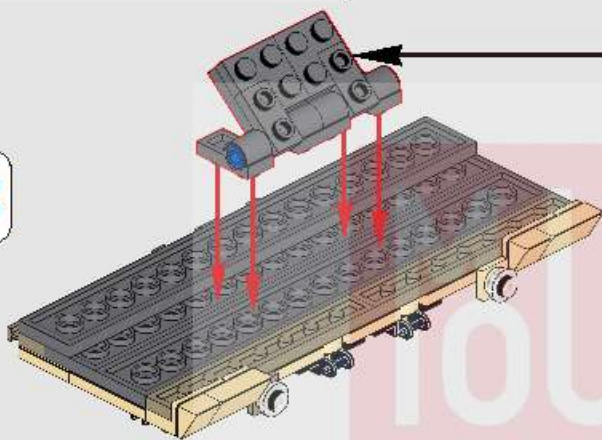

68

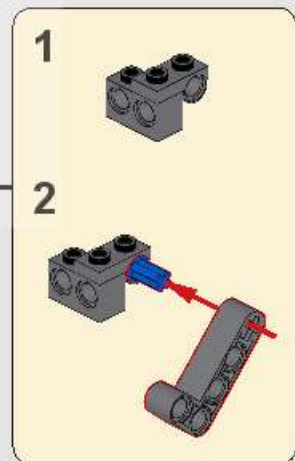
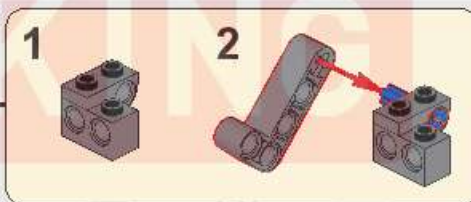
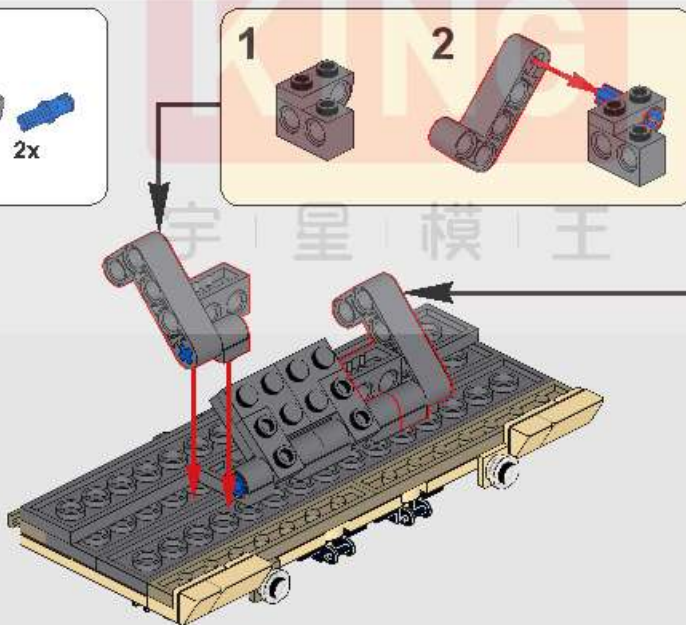

69

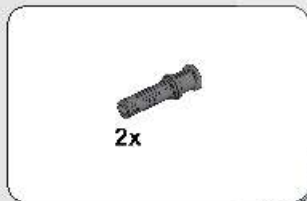
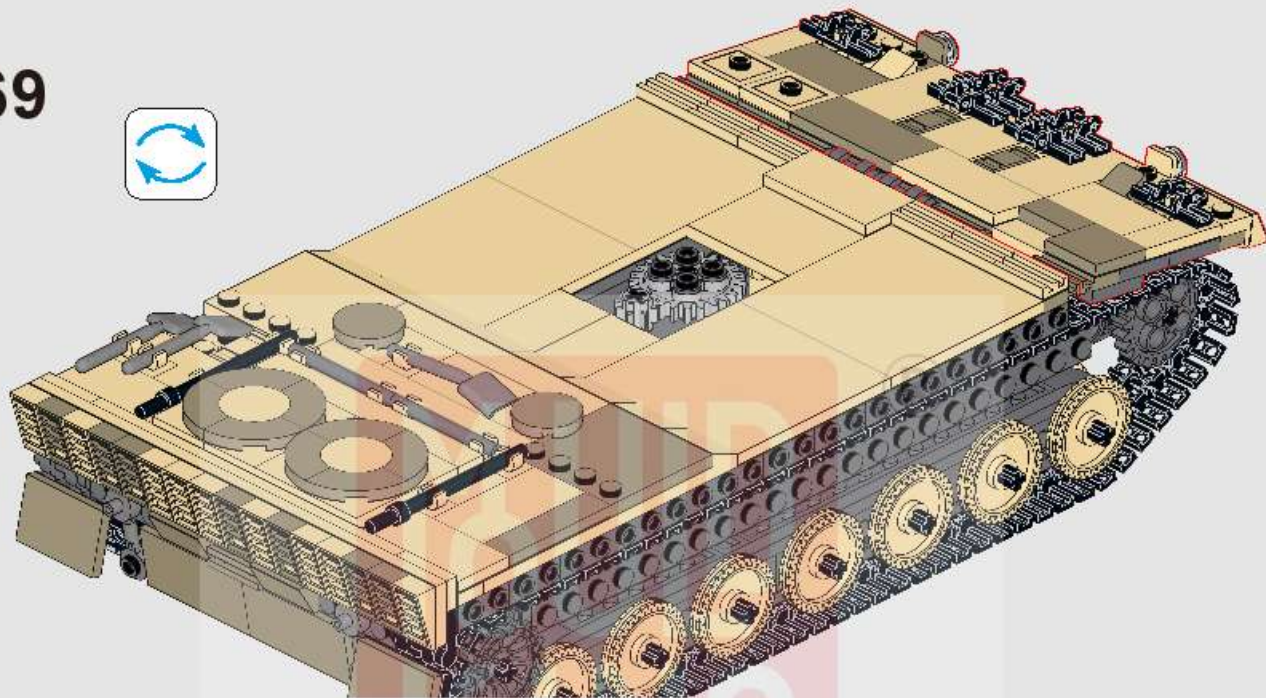

70

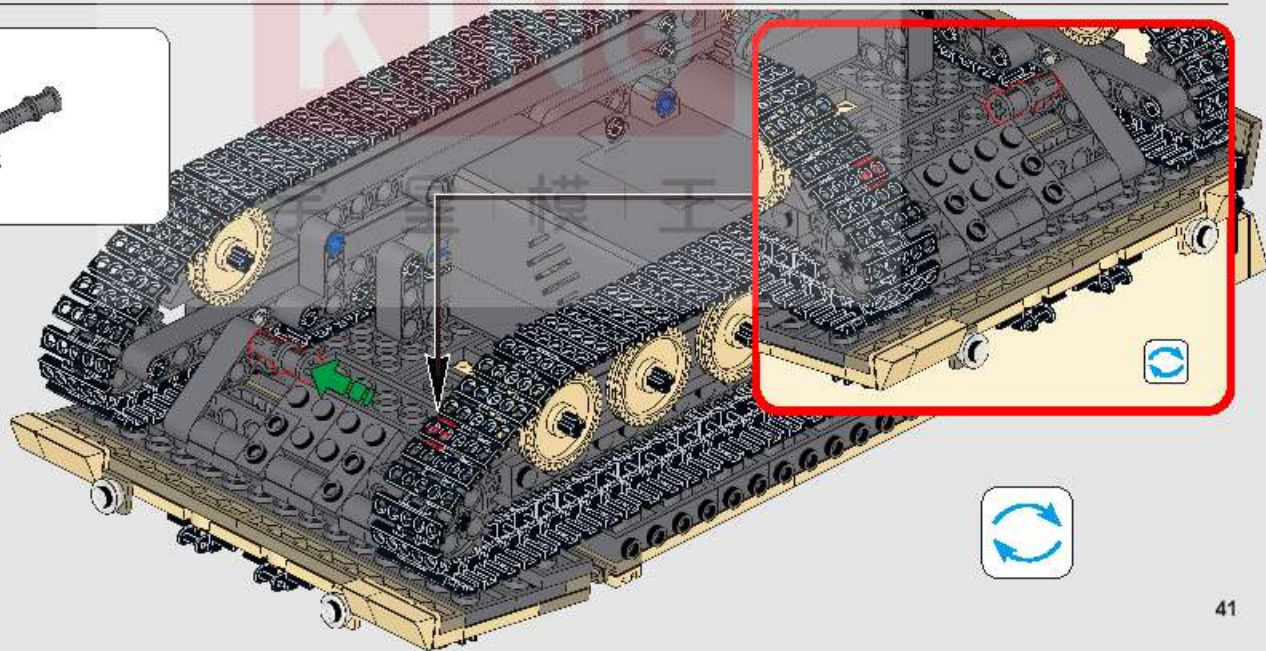

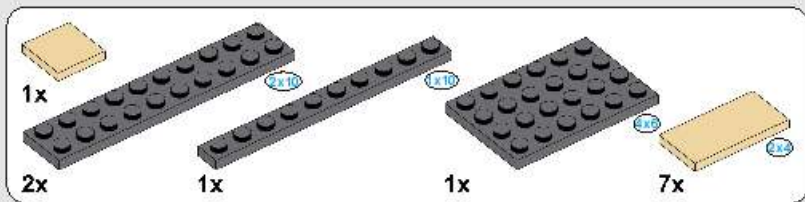

71

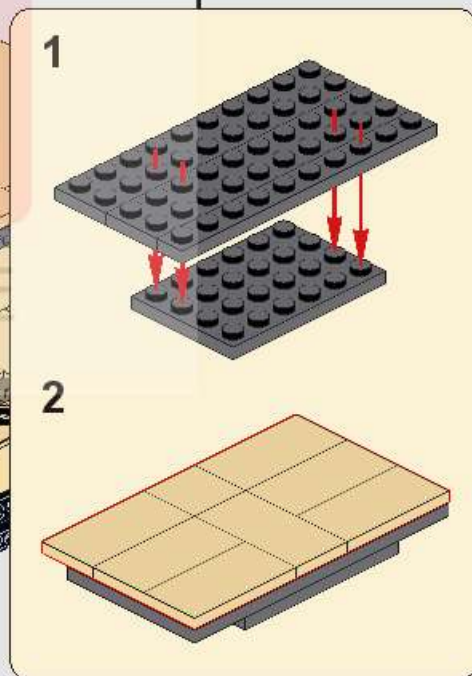
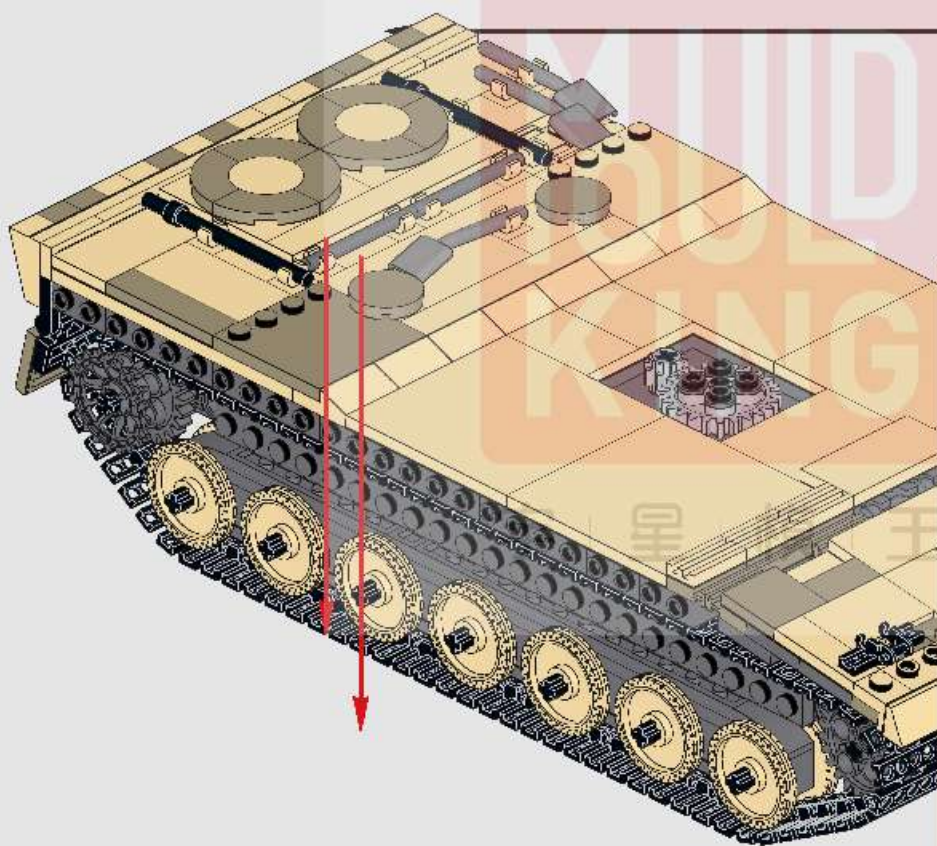
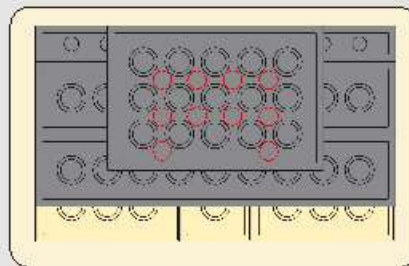

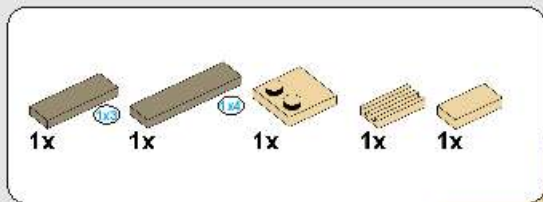

72

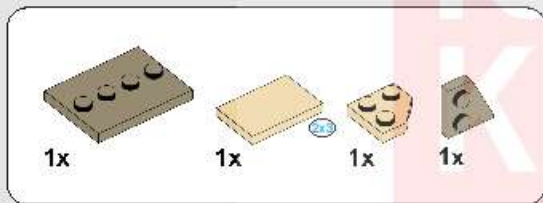
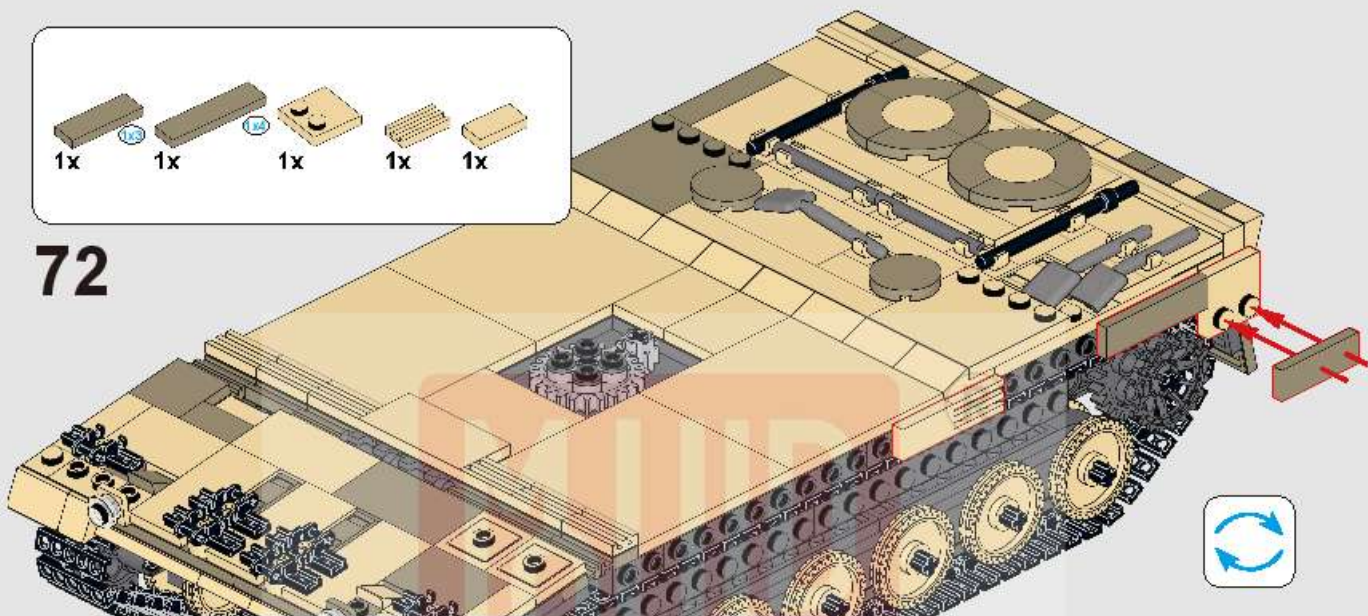

73

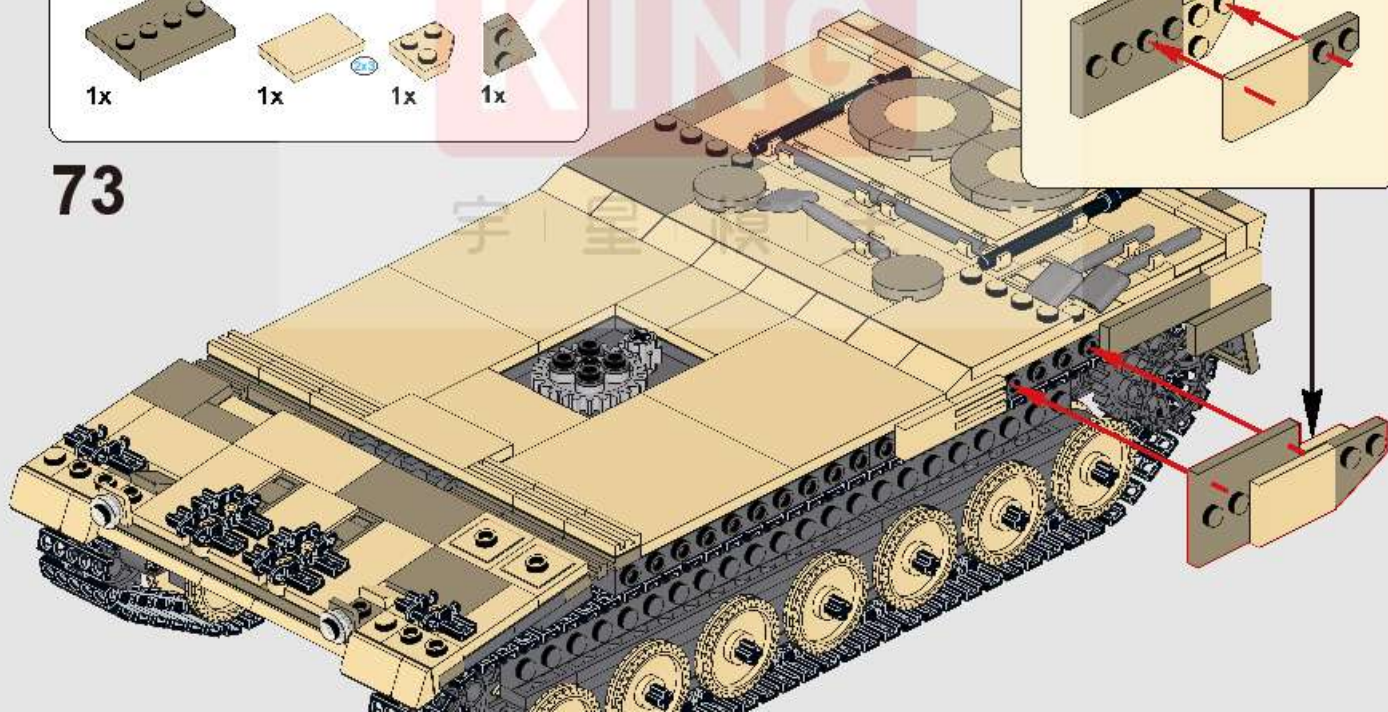
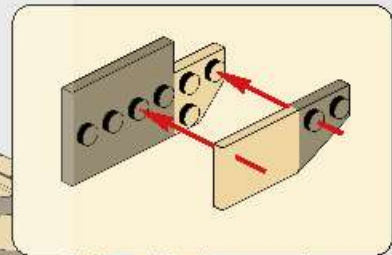

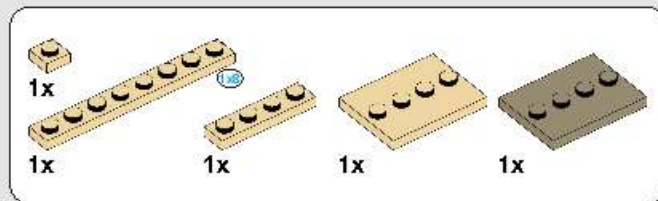
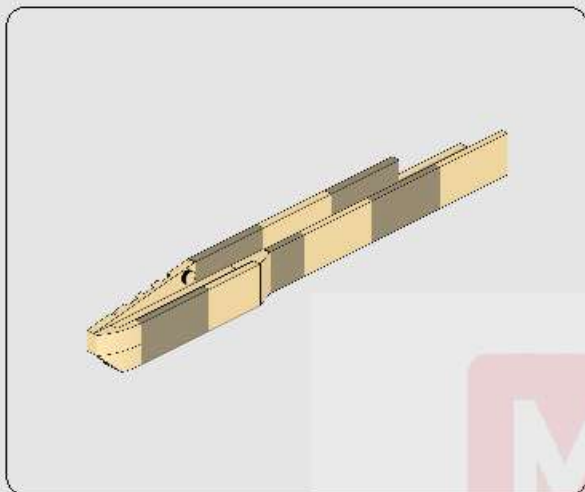

74

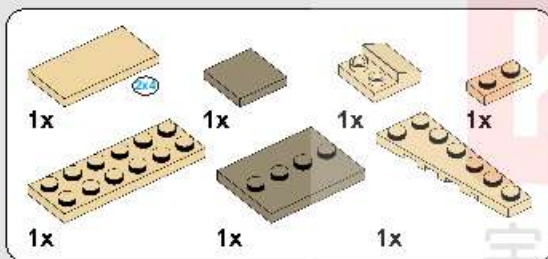
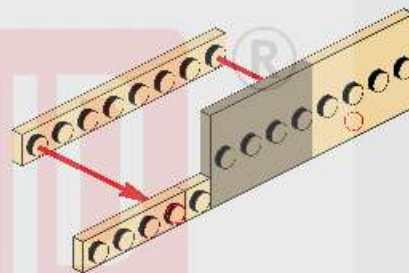

75

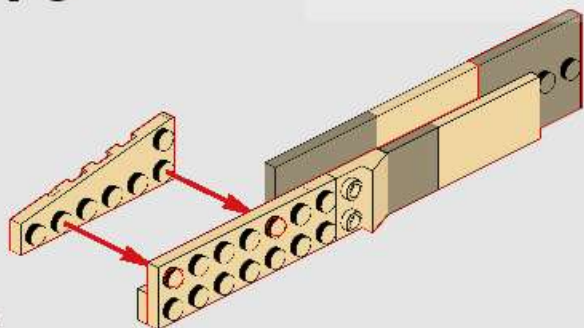

76

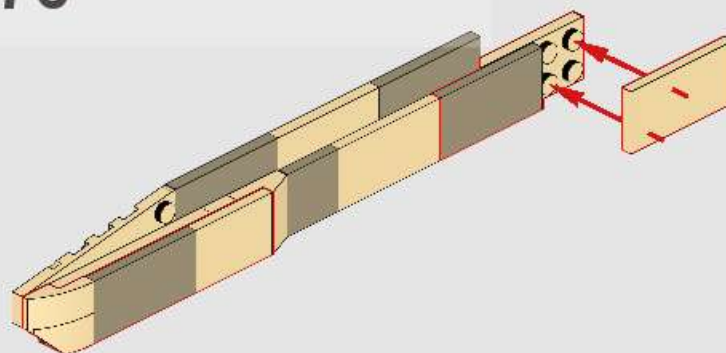

77

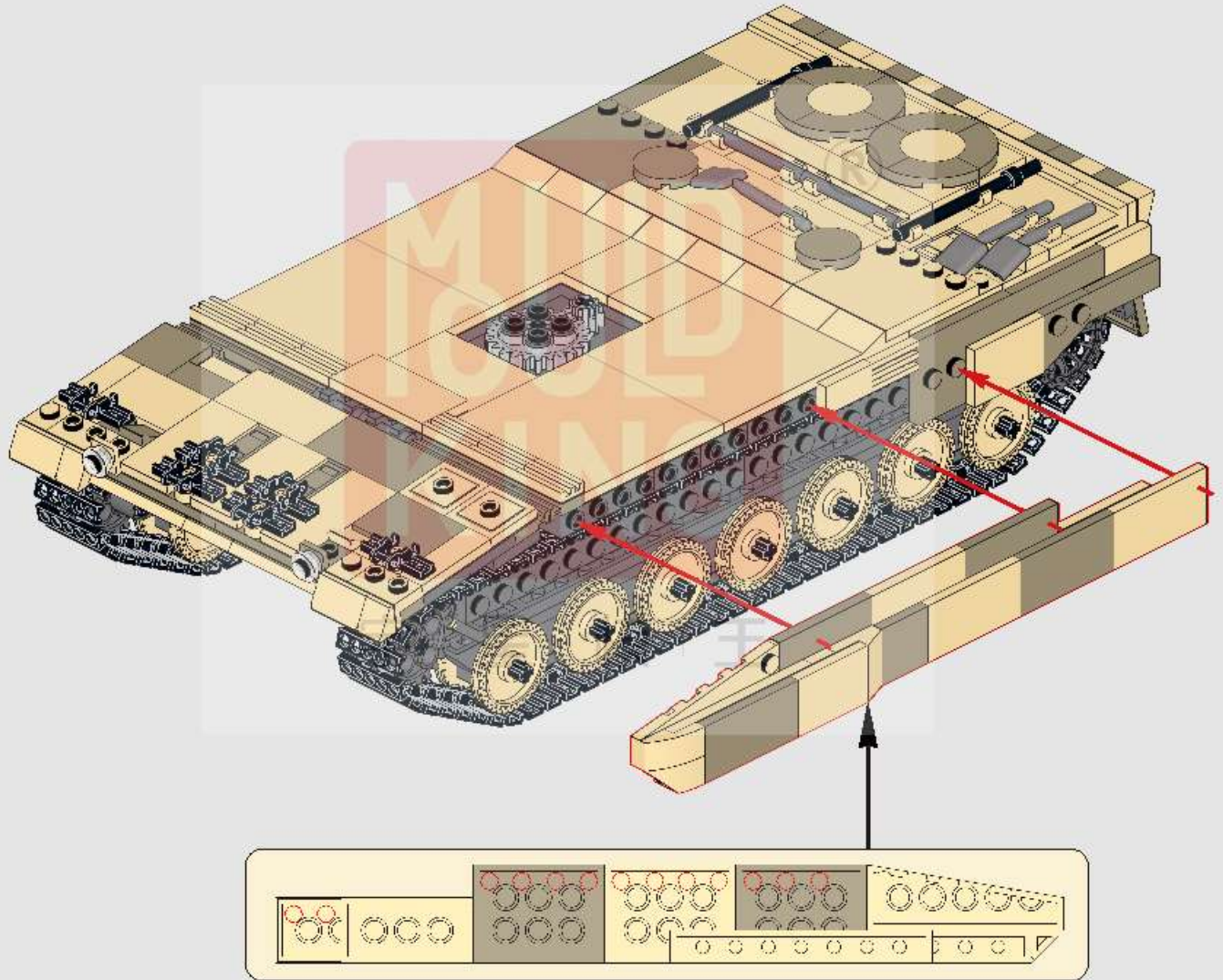

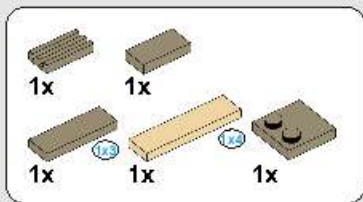

78

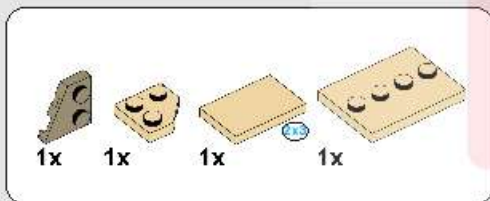
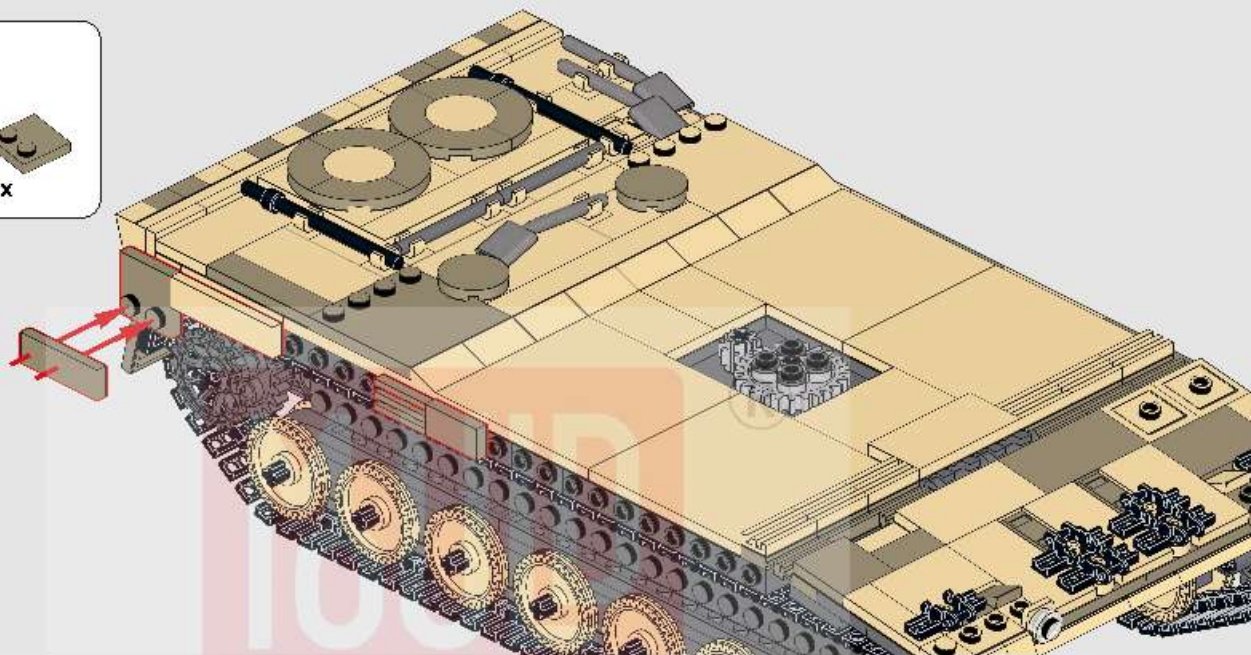

79

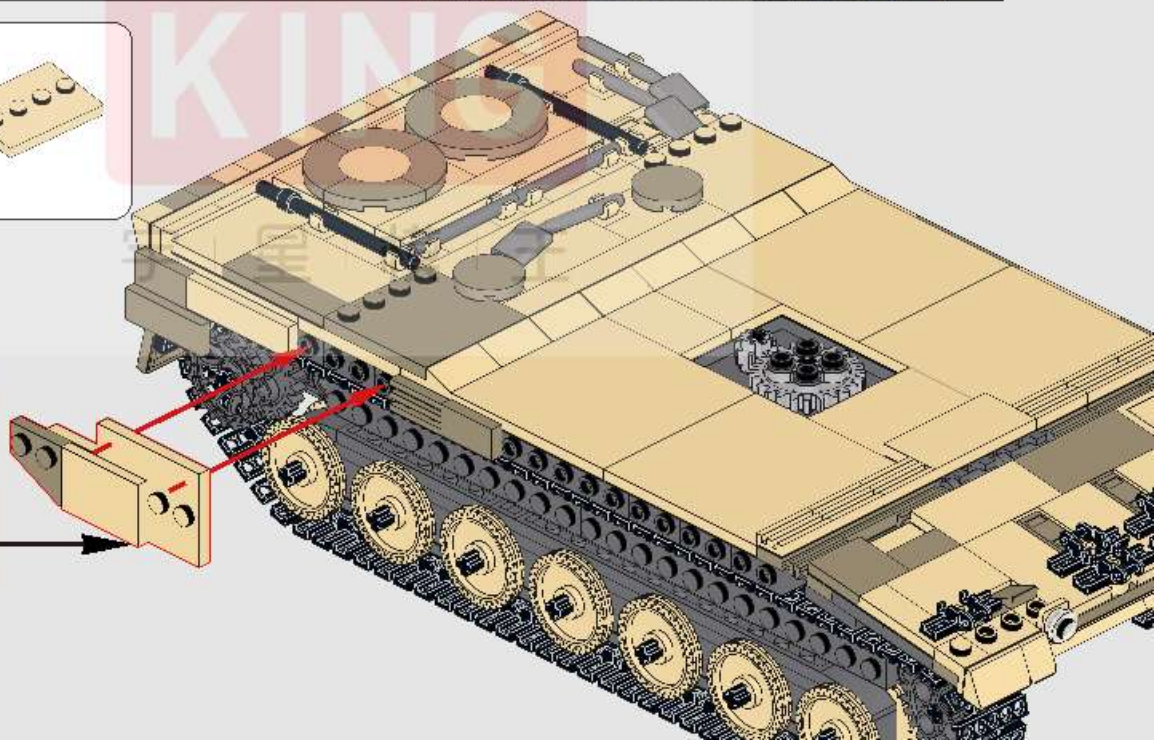
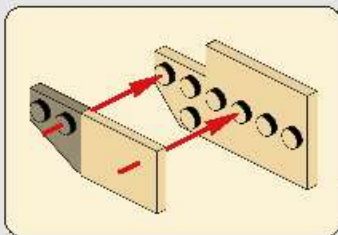

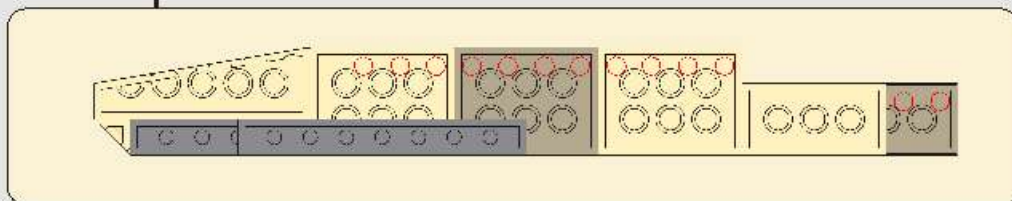
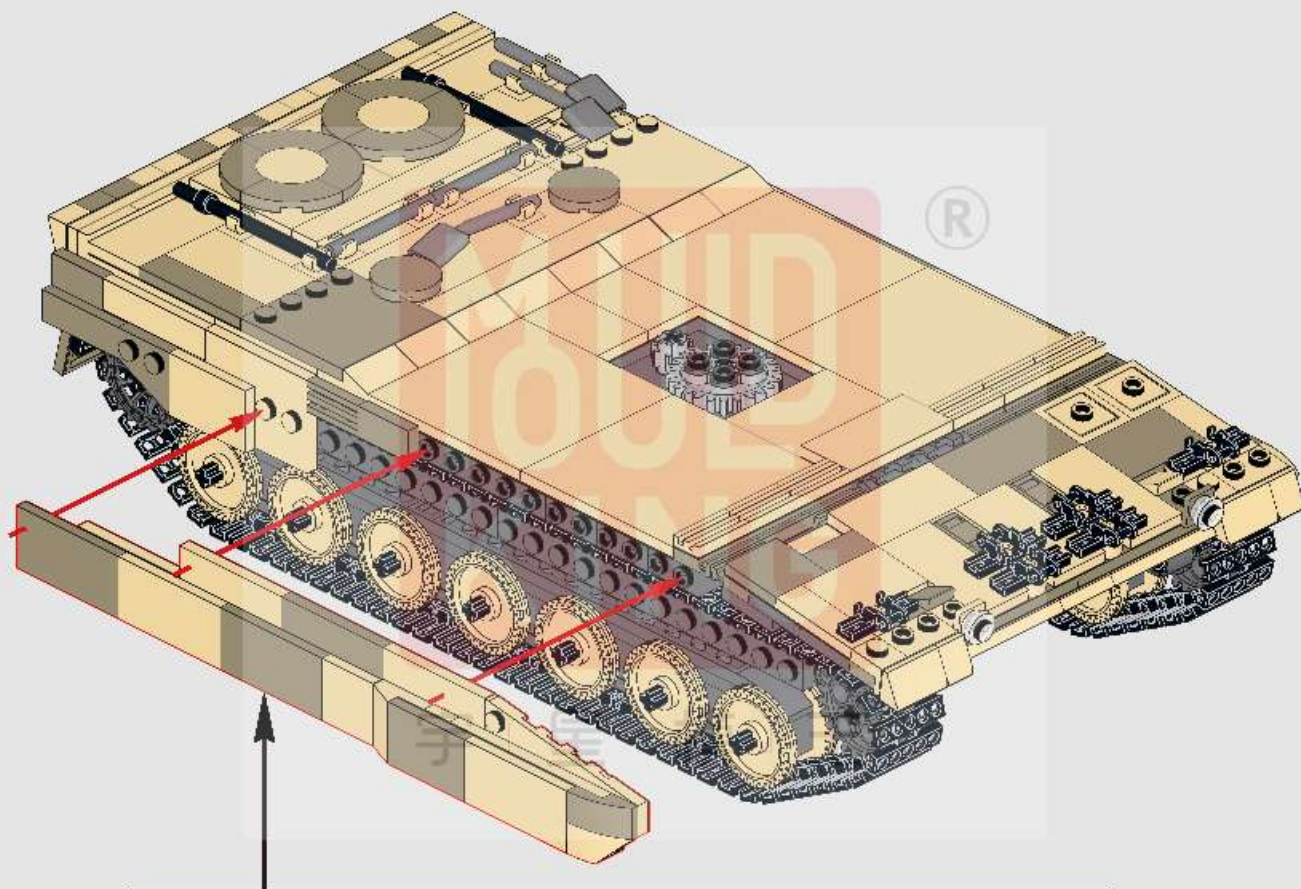

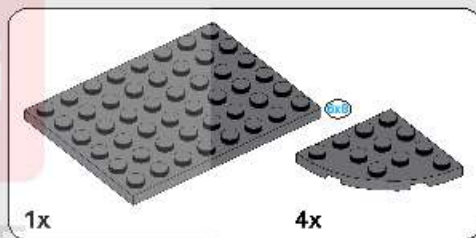
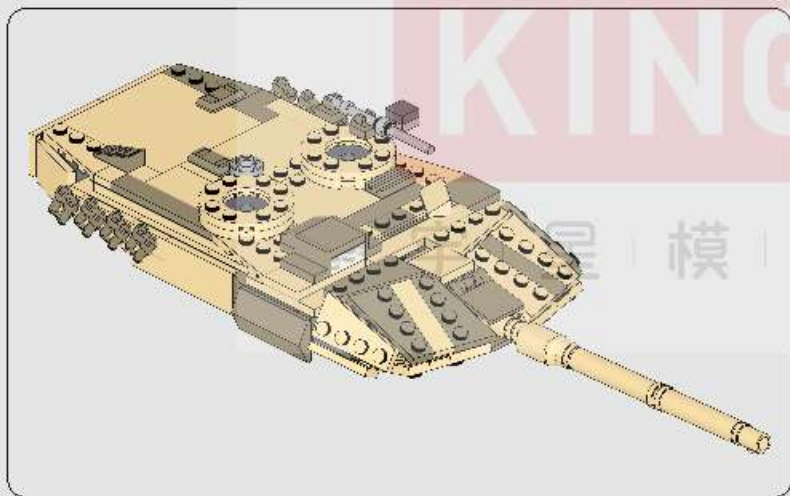
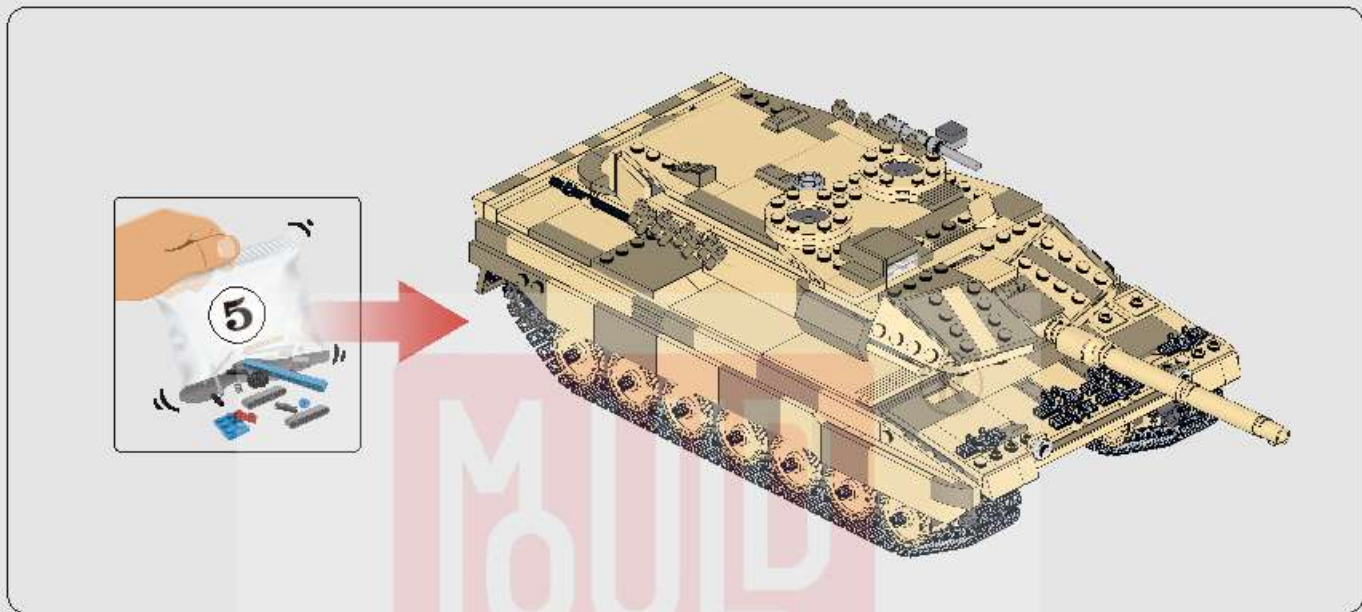

84

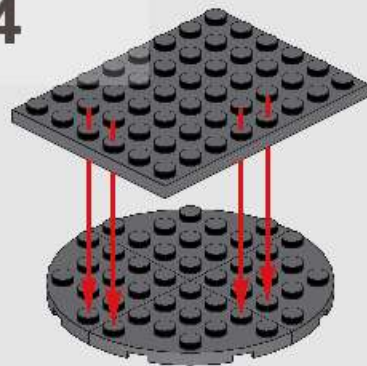

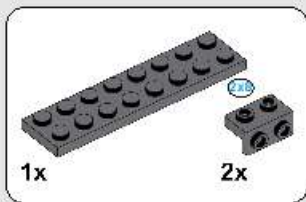

85

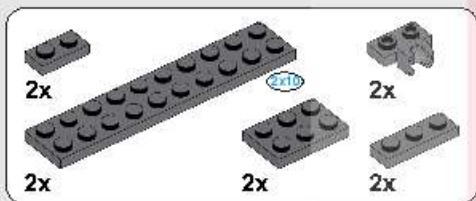
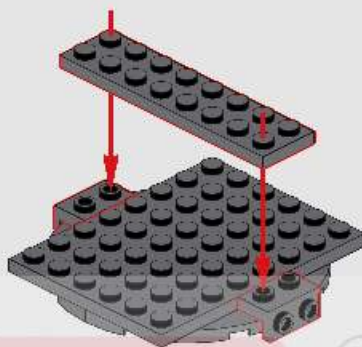

86

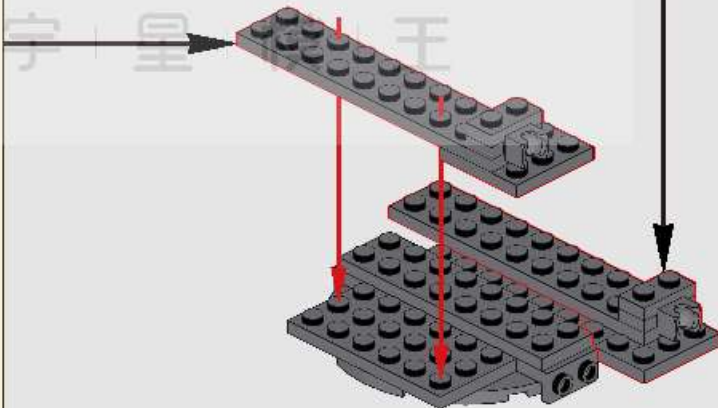
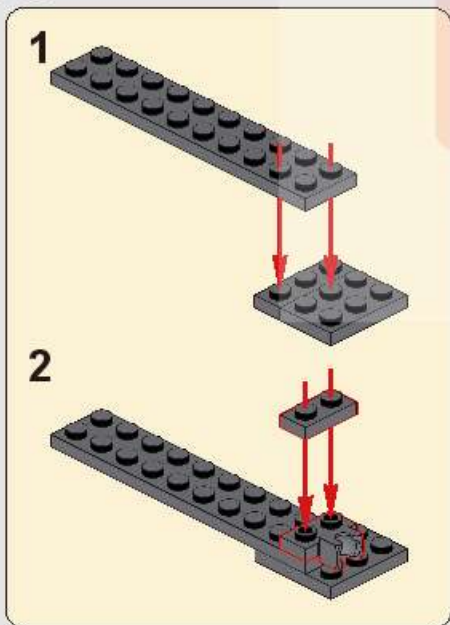
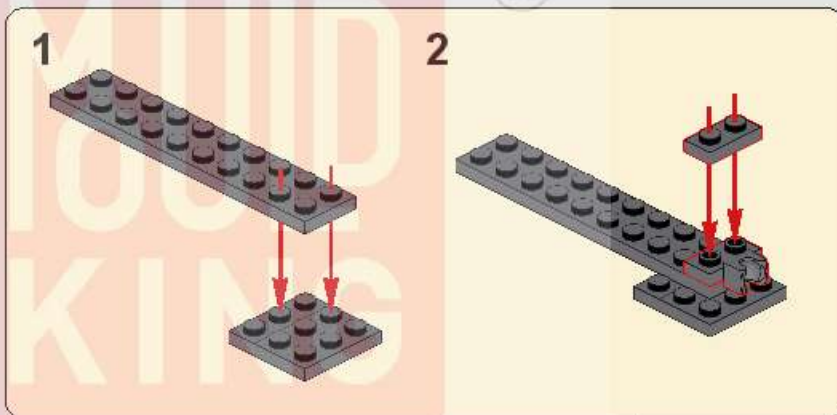

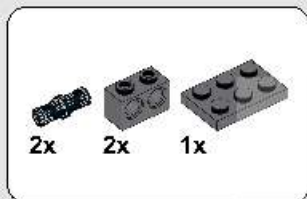
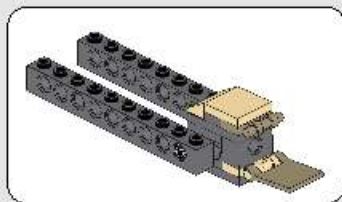

87

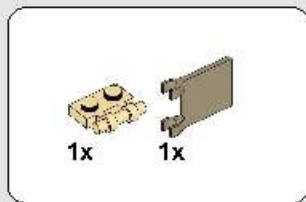

88

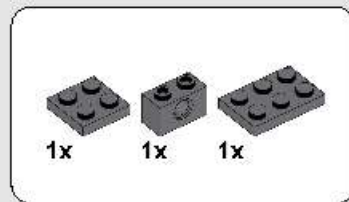

89

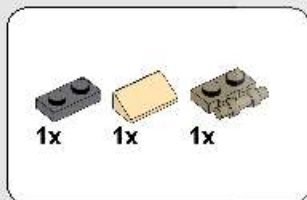
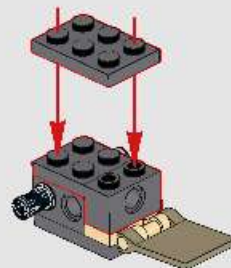
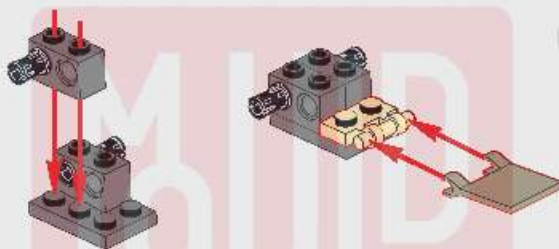

90

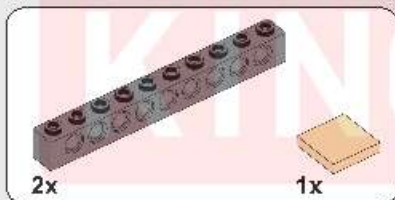

91

92

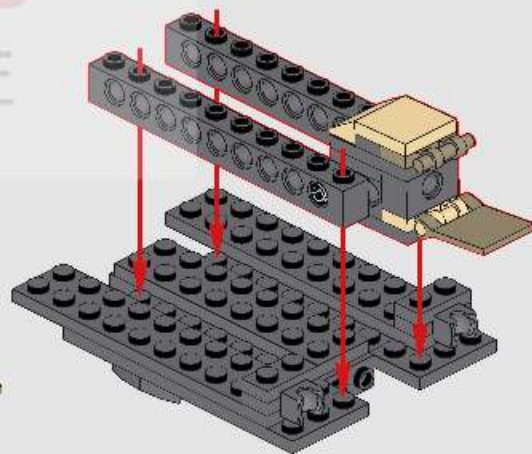
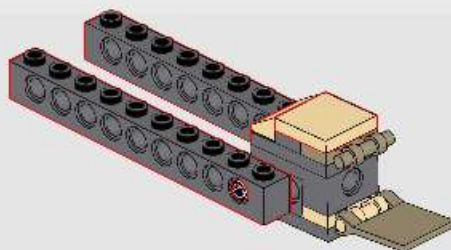
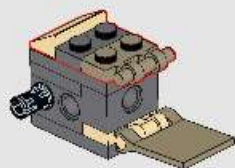

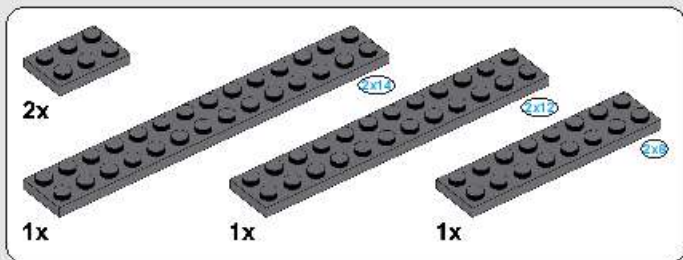

93

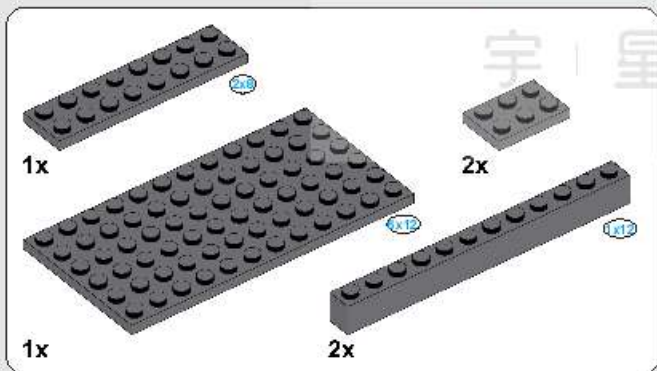
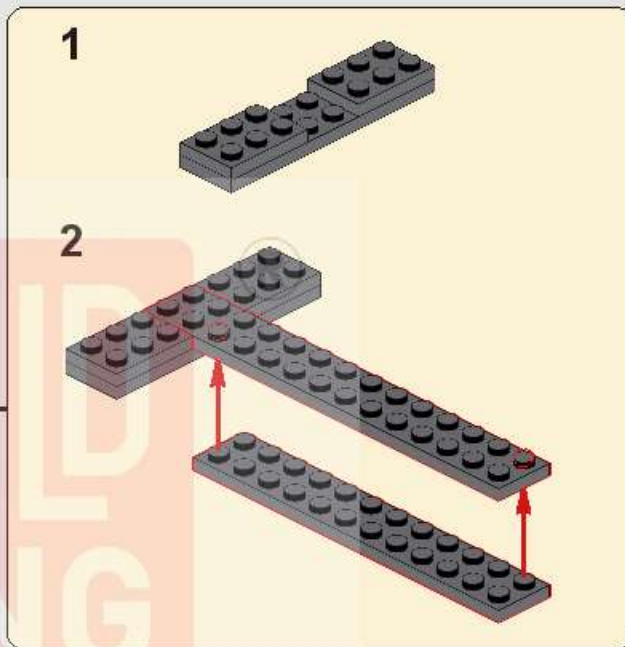
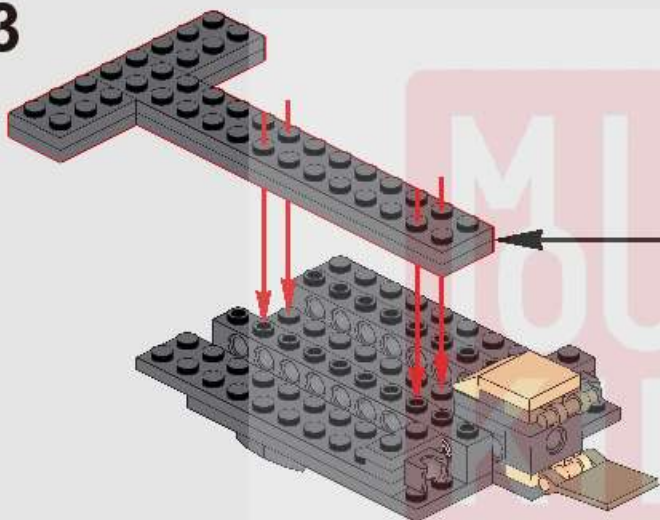

94

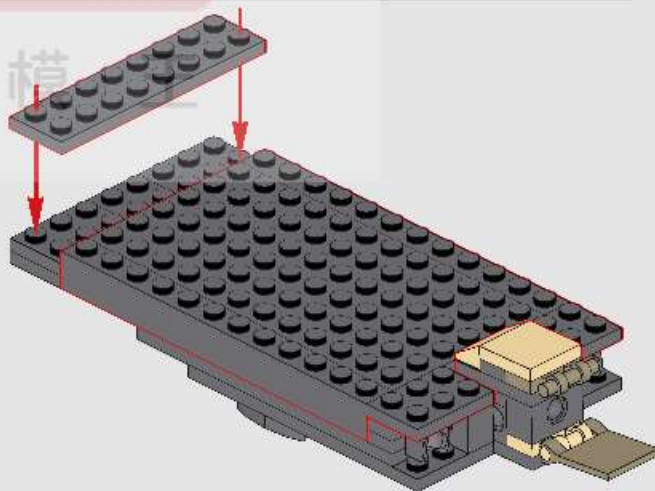

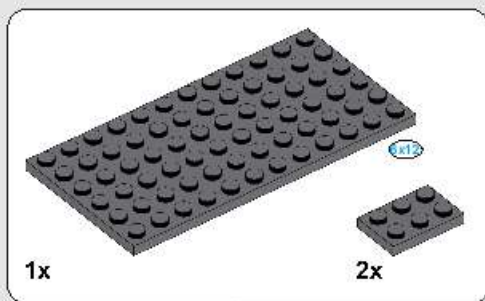

95

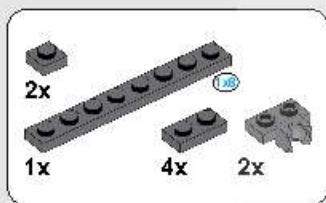
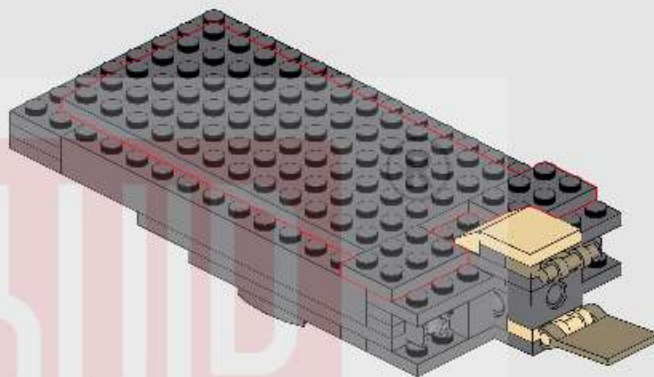

96

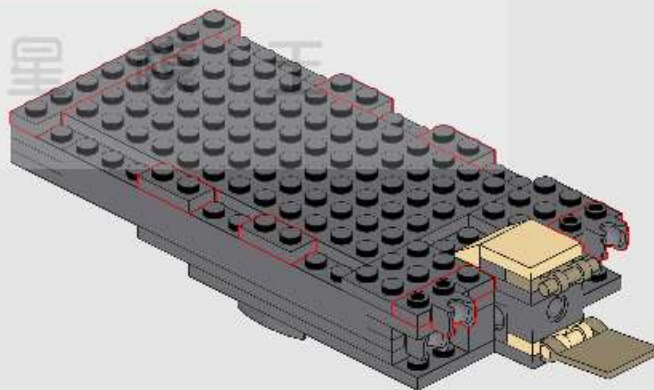

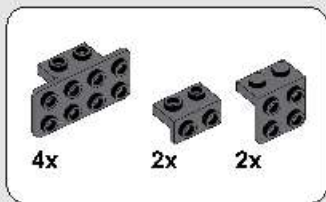

97

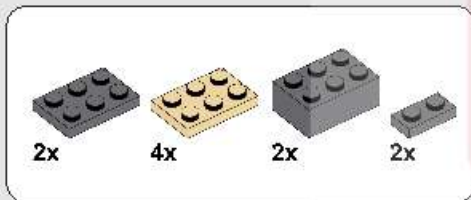
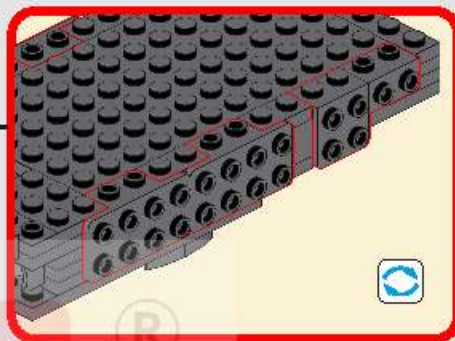
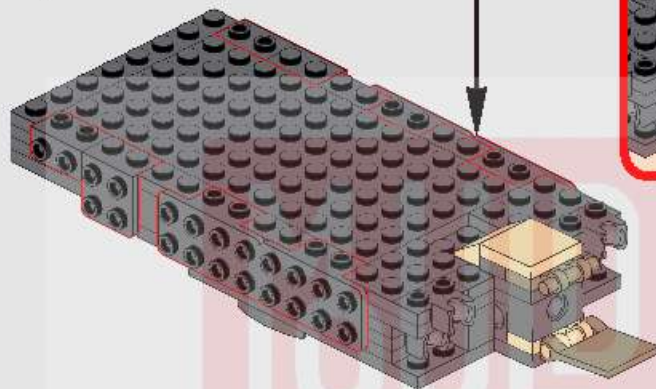

98

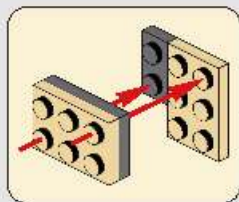
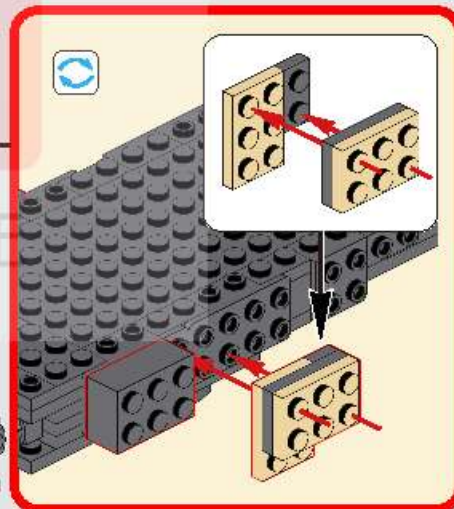
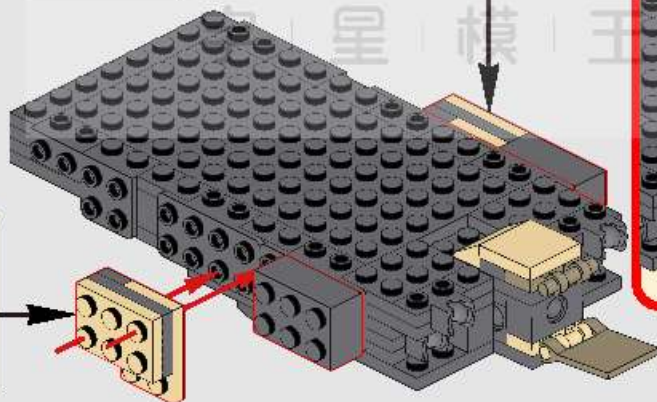

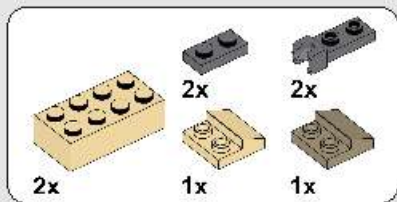

99

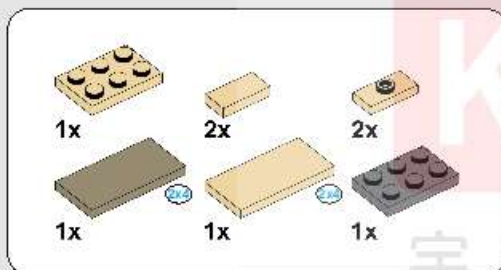
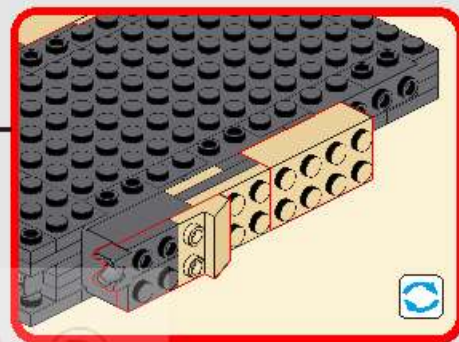
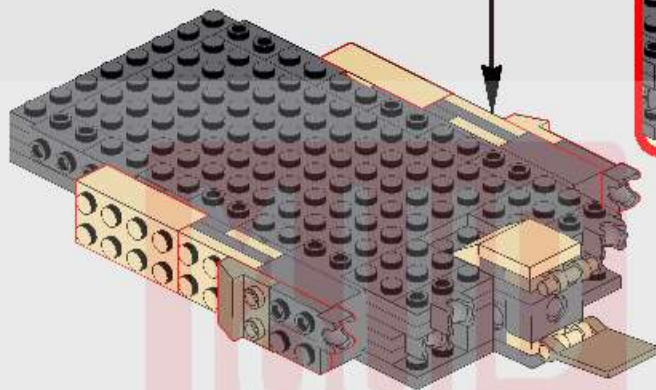

100

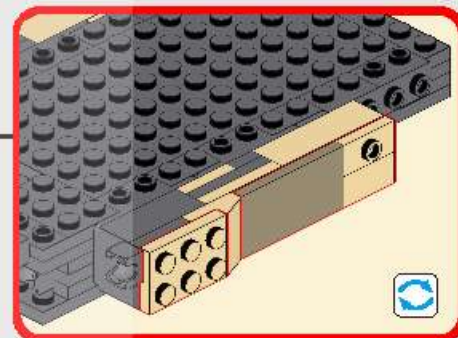
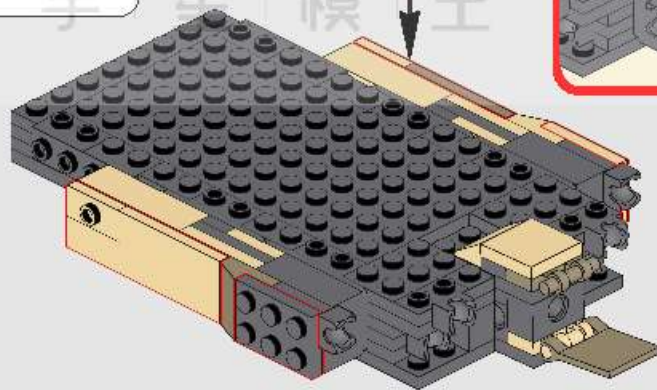

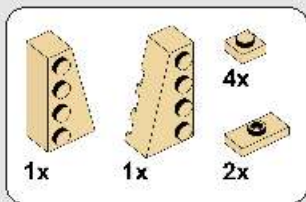

101

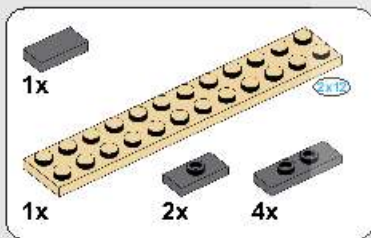
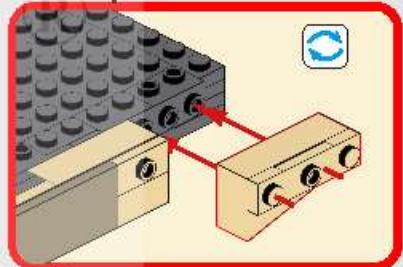
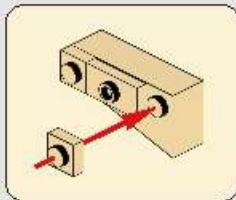
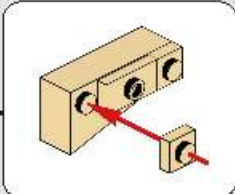
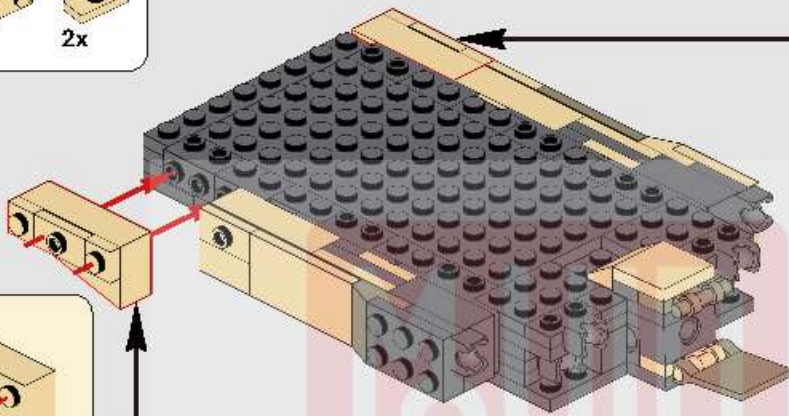

102

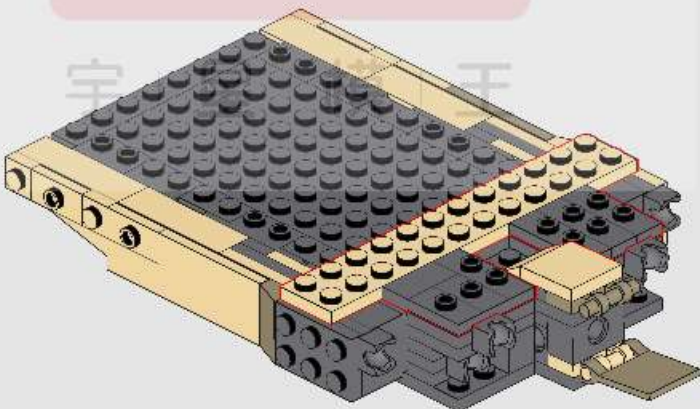

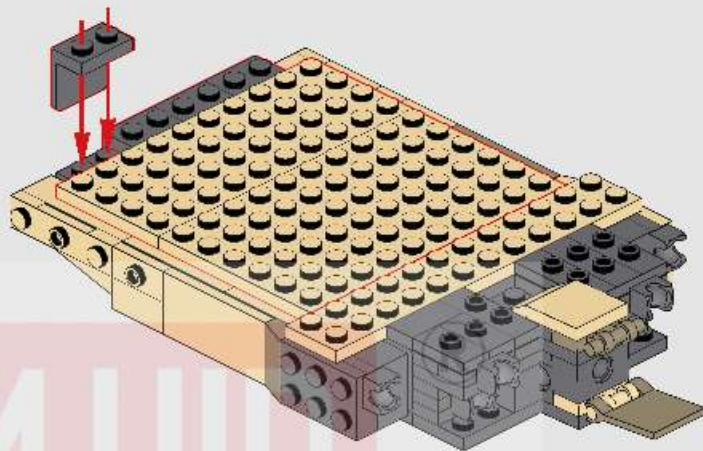
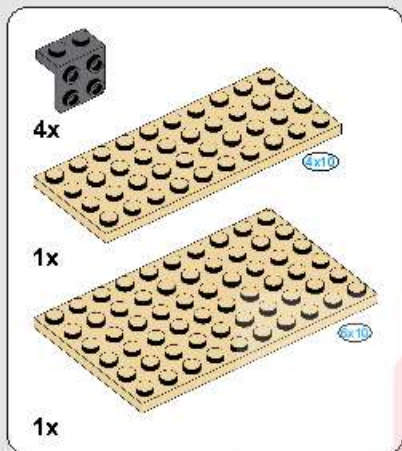

103

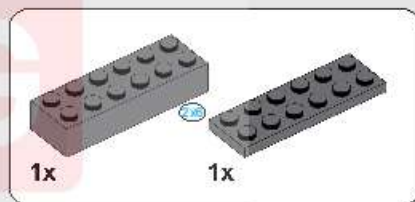
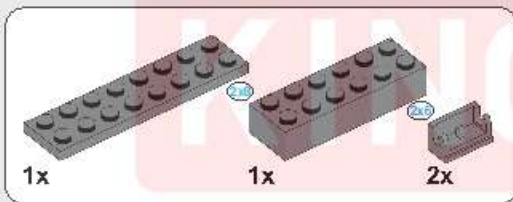
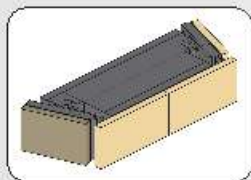

104 宇 | 星 | 模 | 105

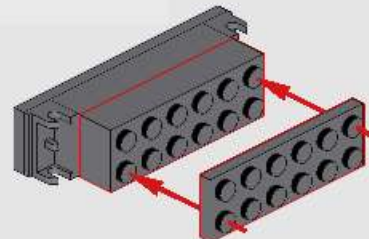
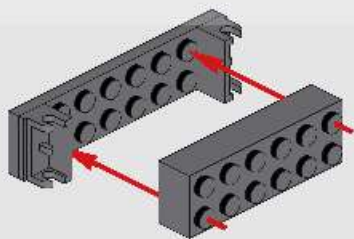

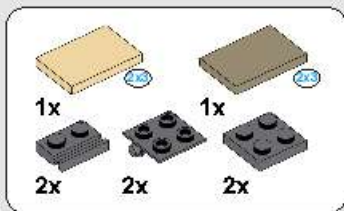

106

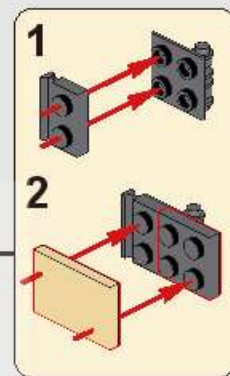
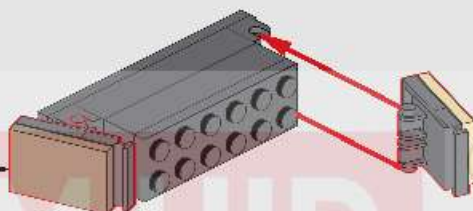
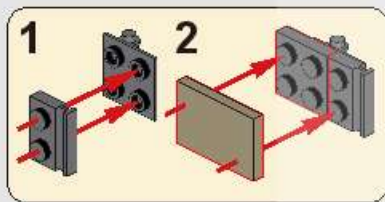

107

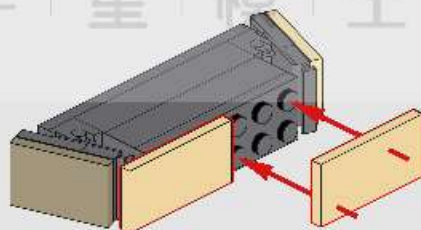

MOULD KING

宇 | 星 | 模 | 王

108

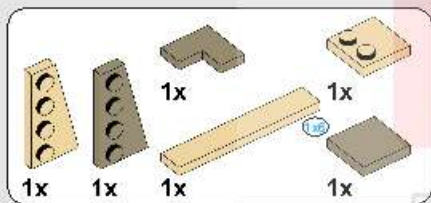
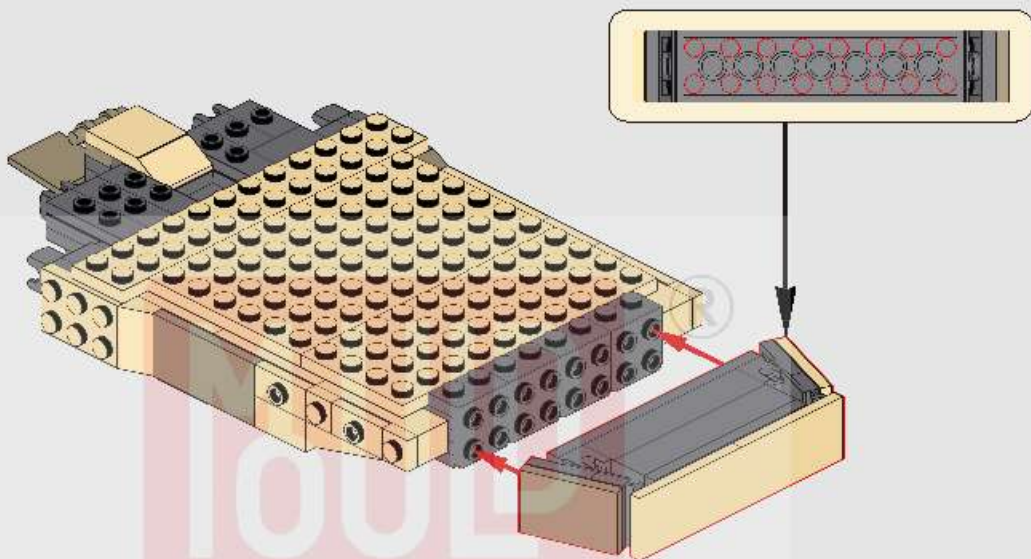

109

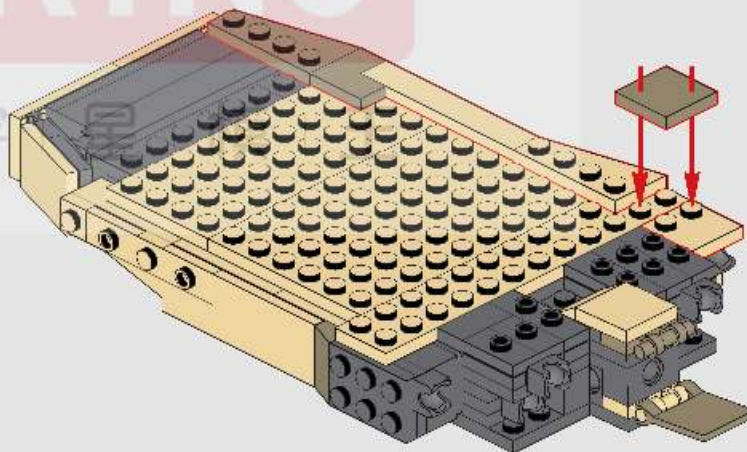

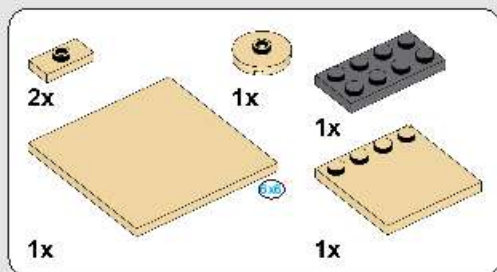

110

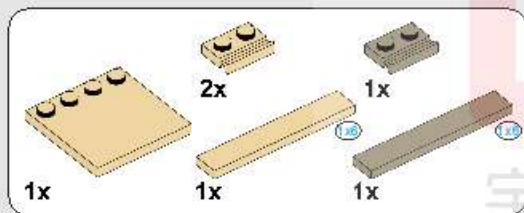
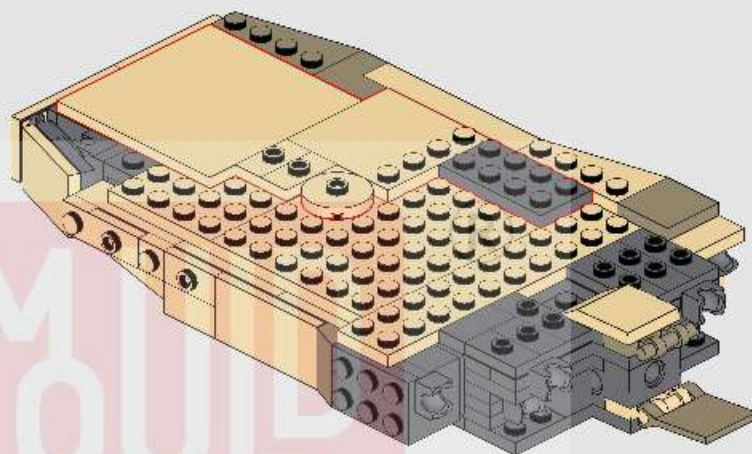

111

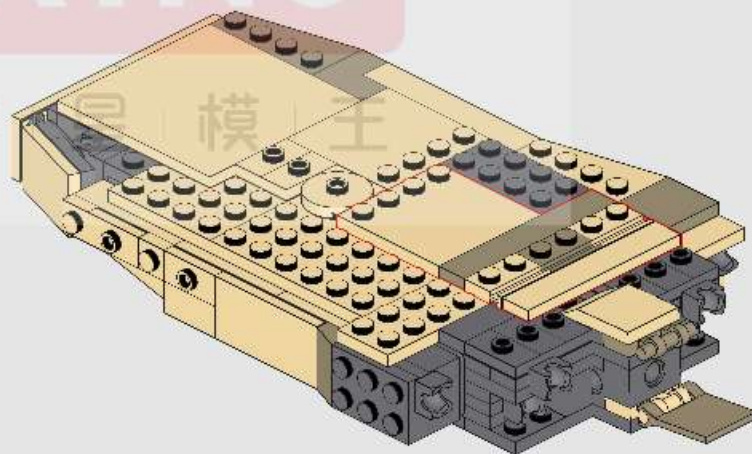

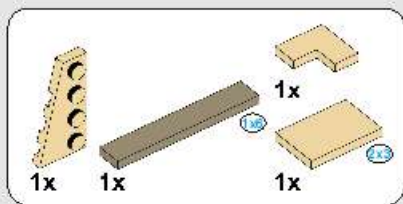

112

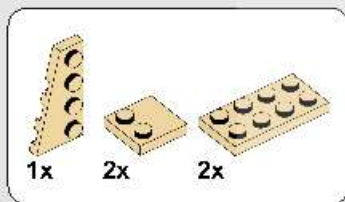
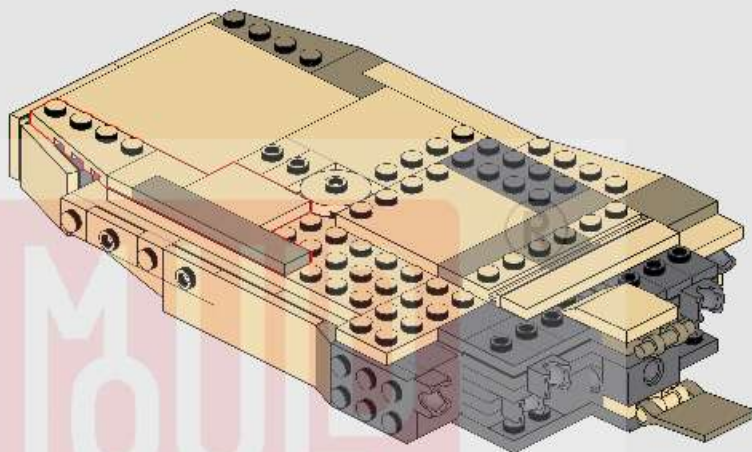

113

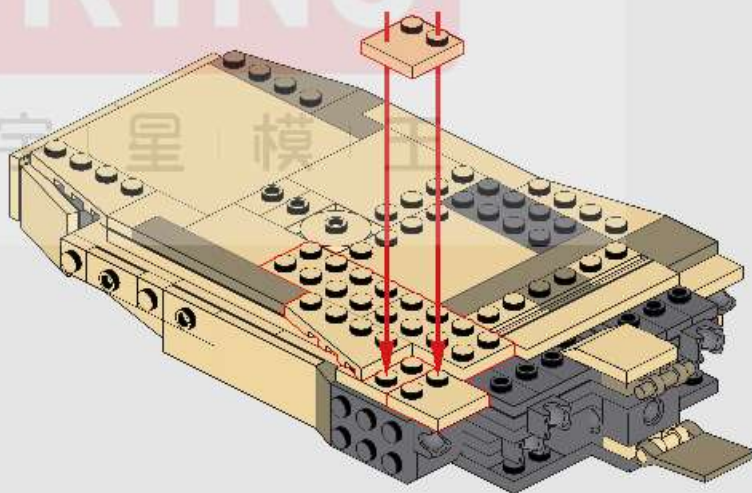

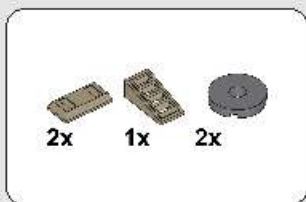

114

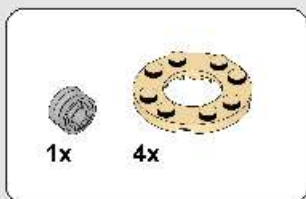
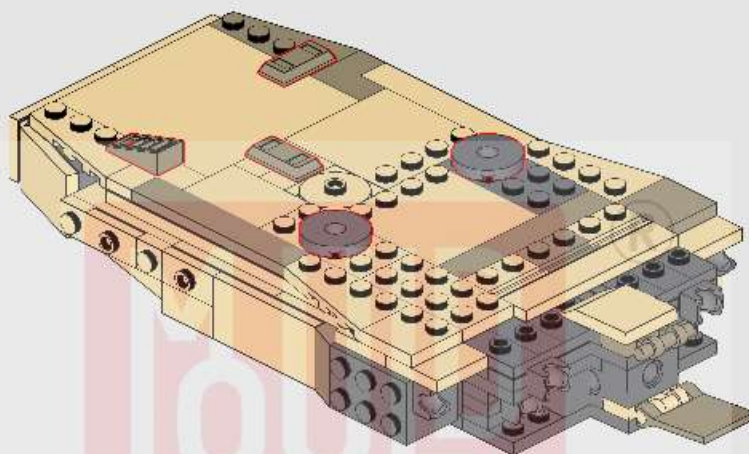

115

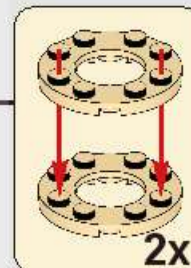
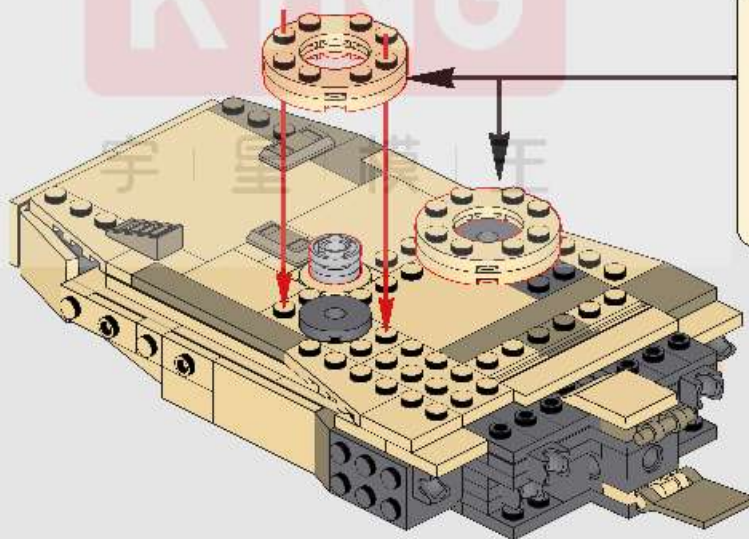

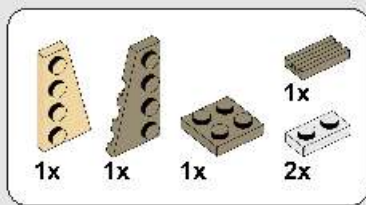

116

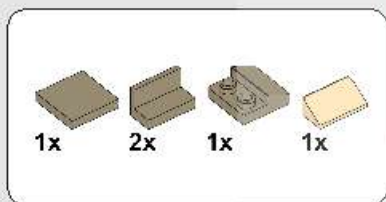
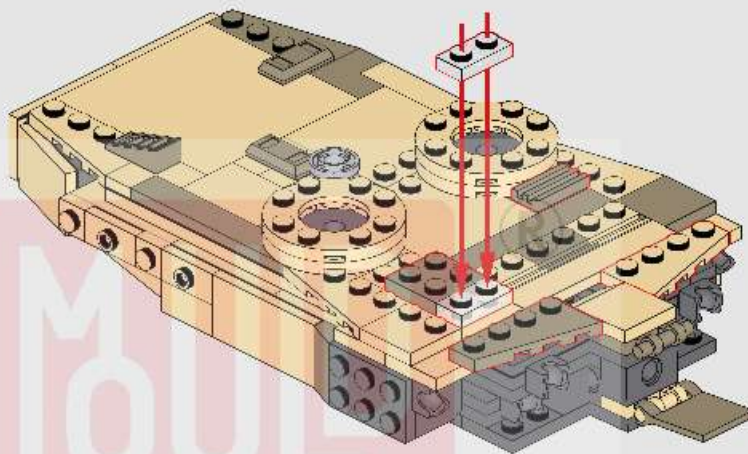

117

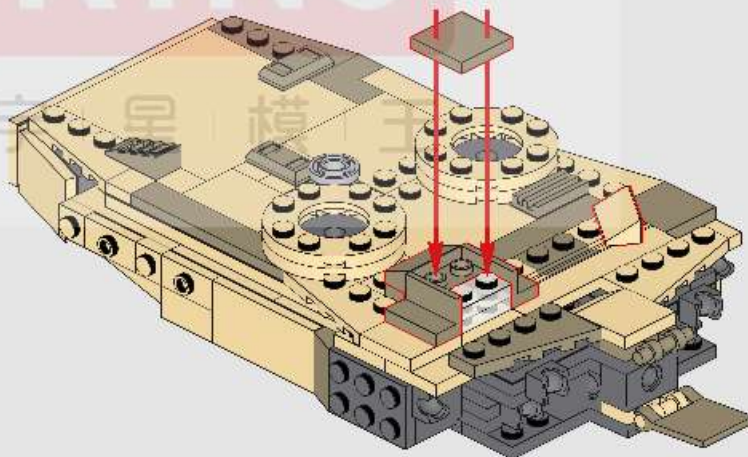

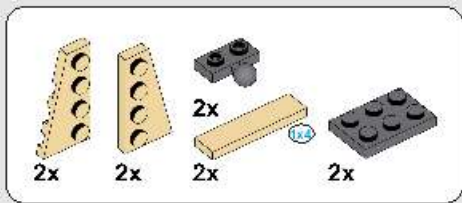

118

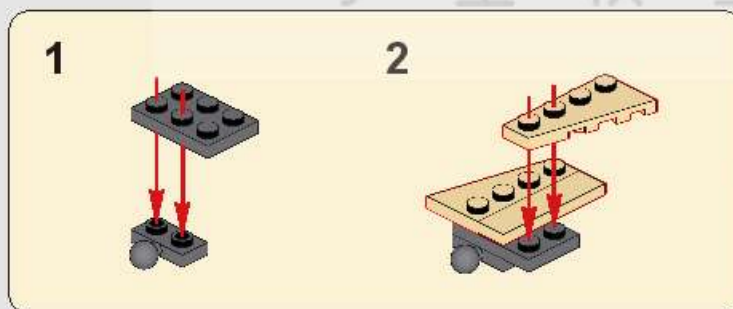
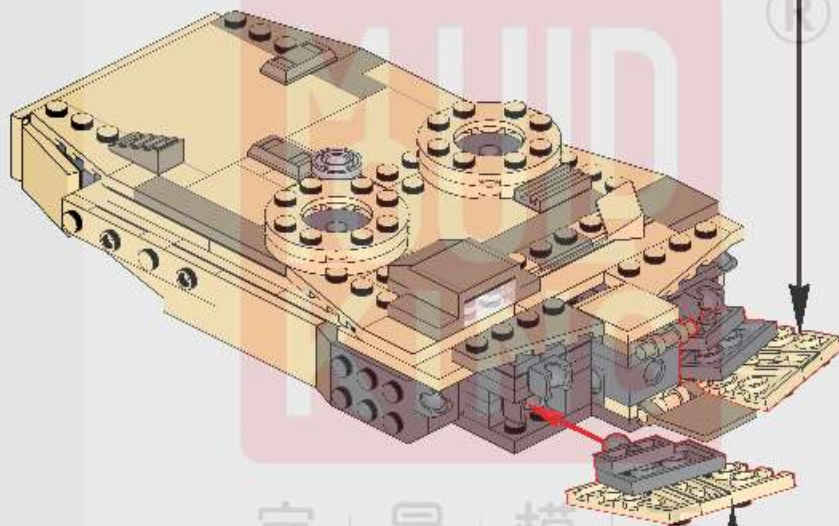
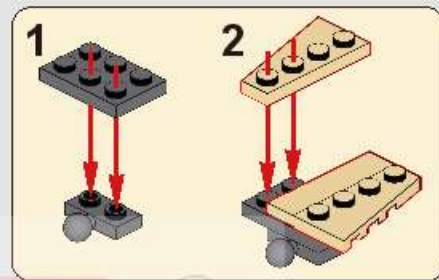

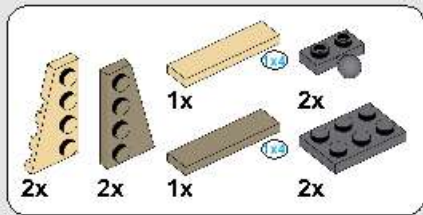

119

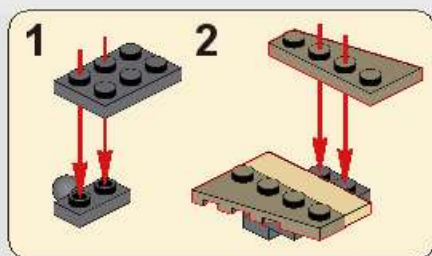
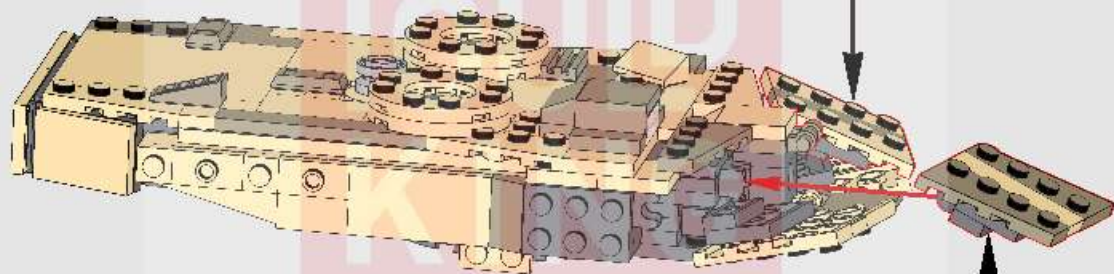
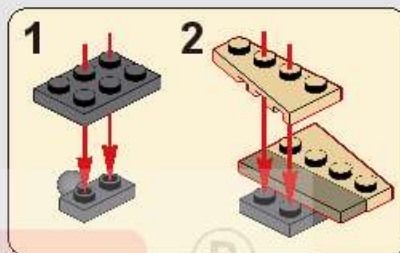

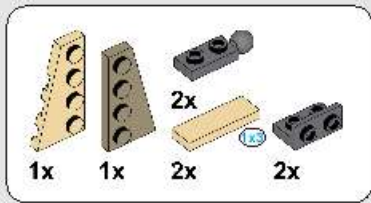

120

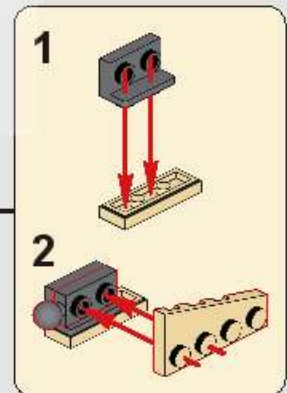
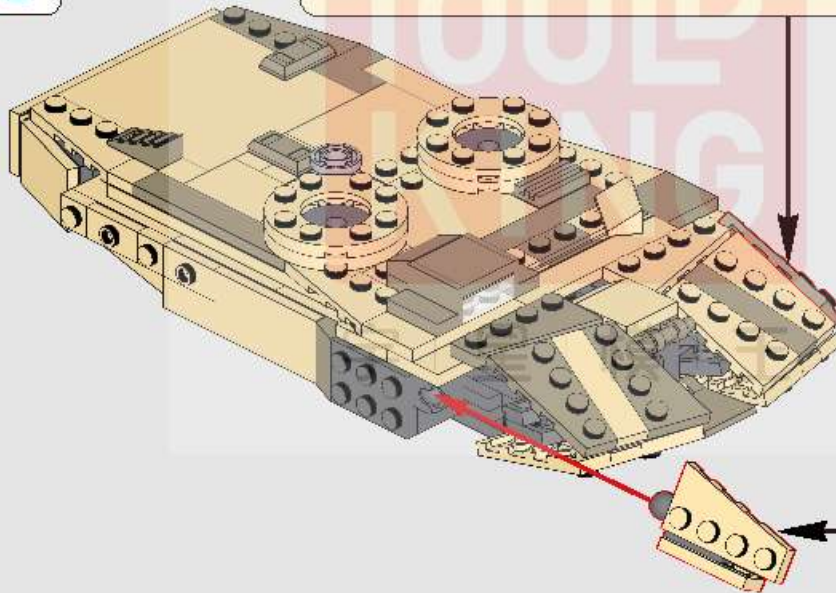
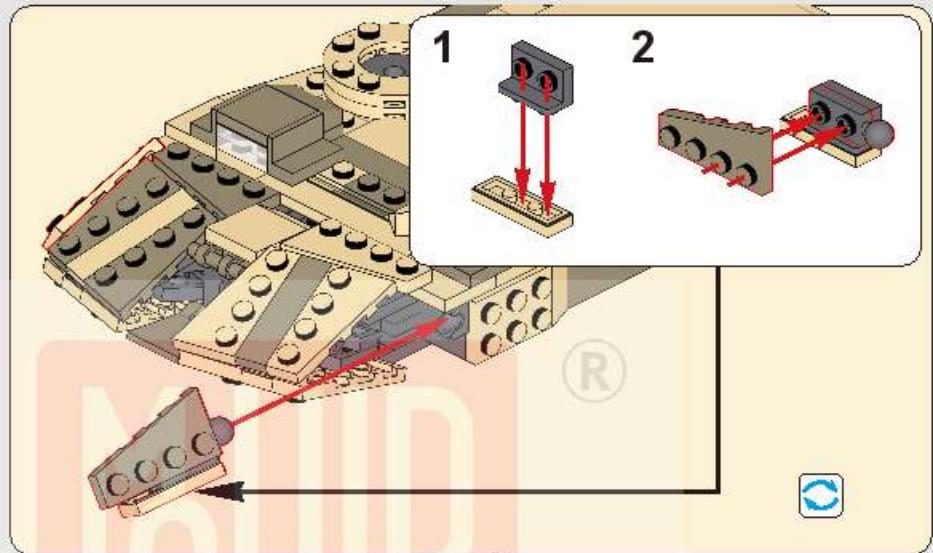

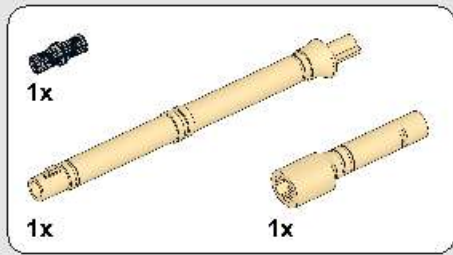

121

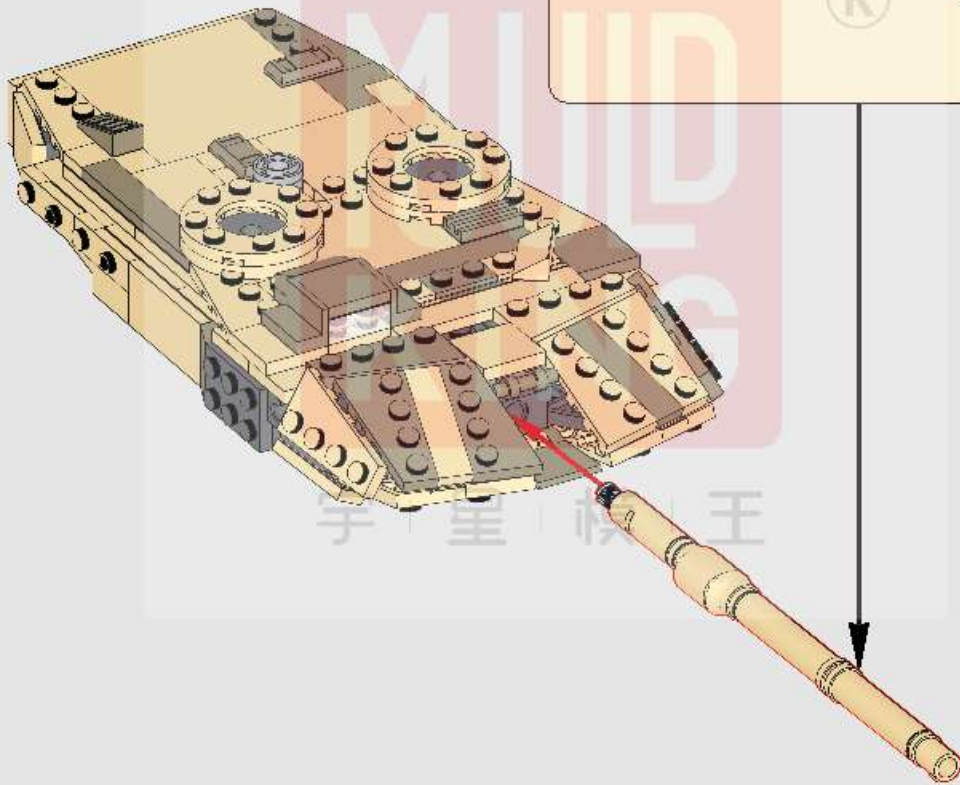
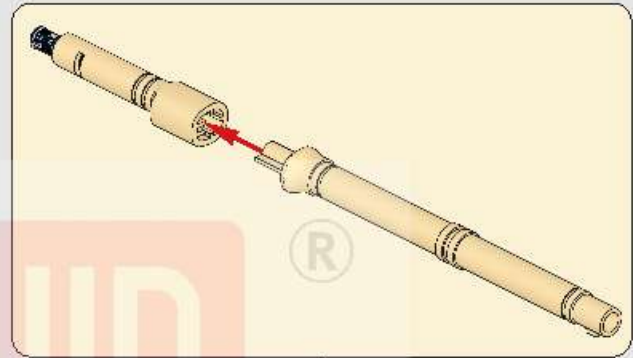

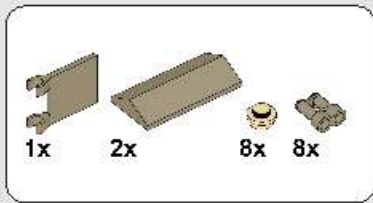

122

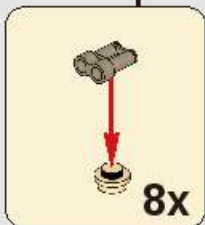
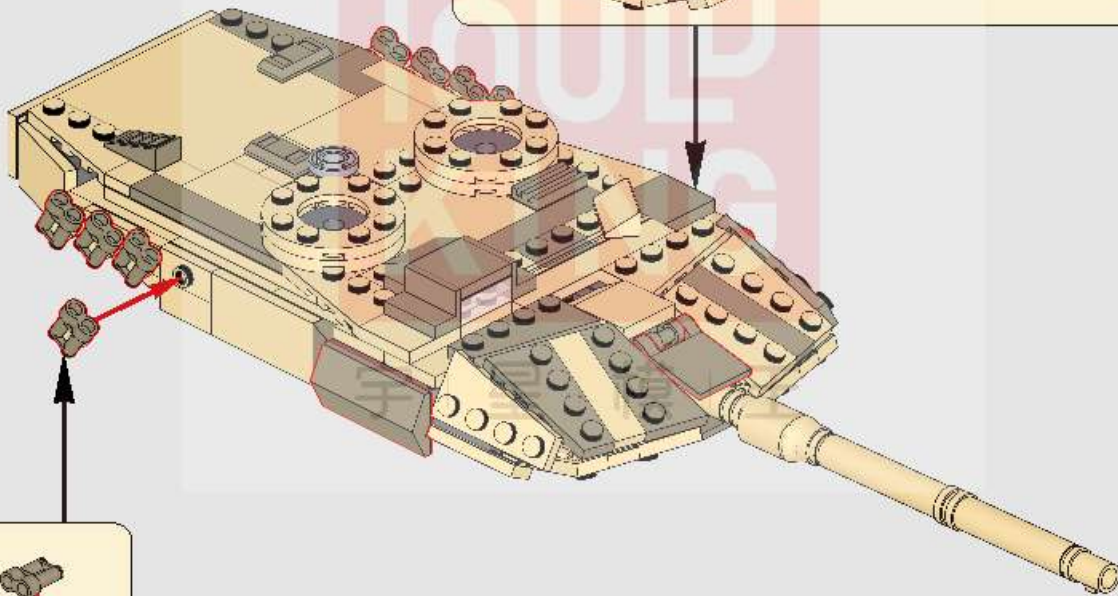
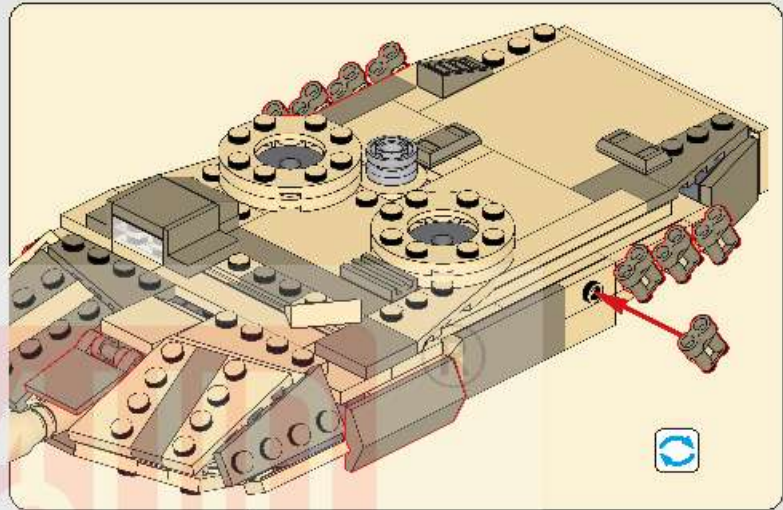

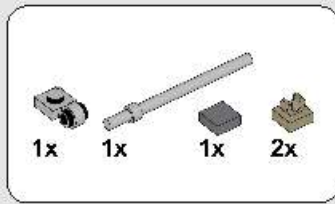

123

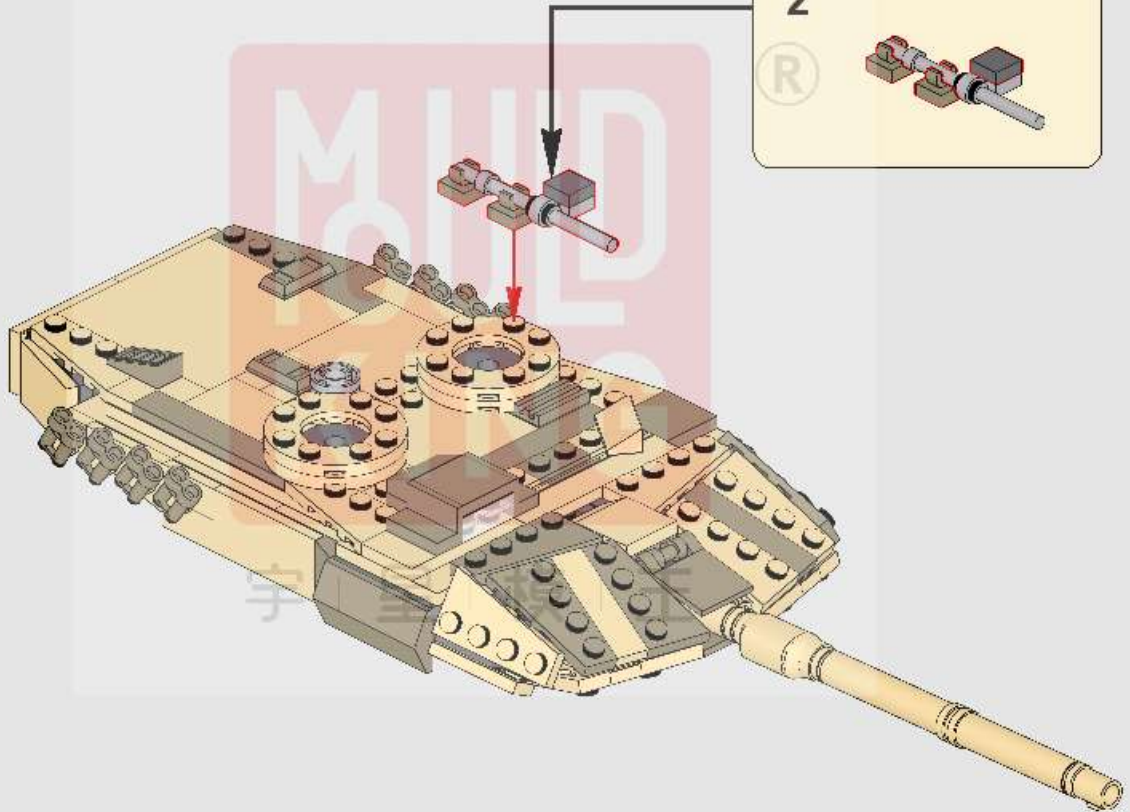
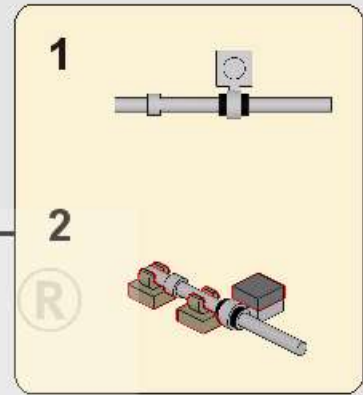

124

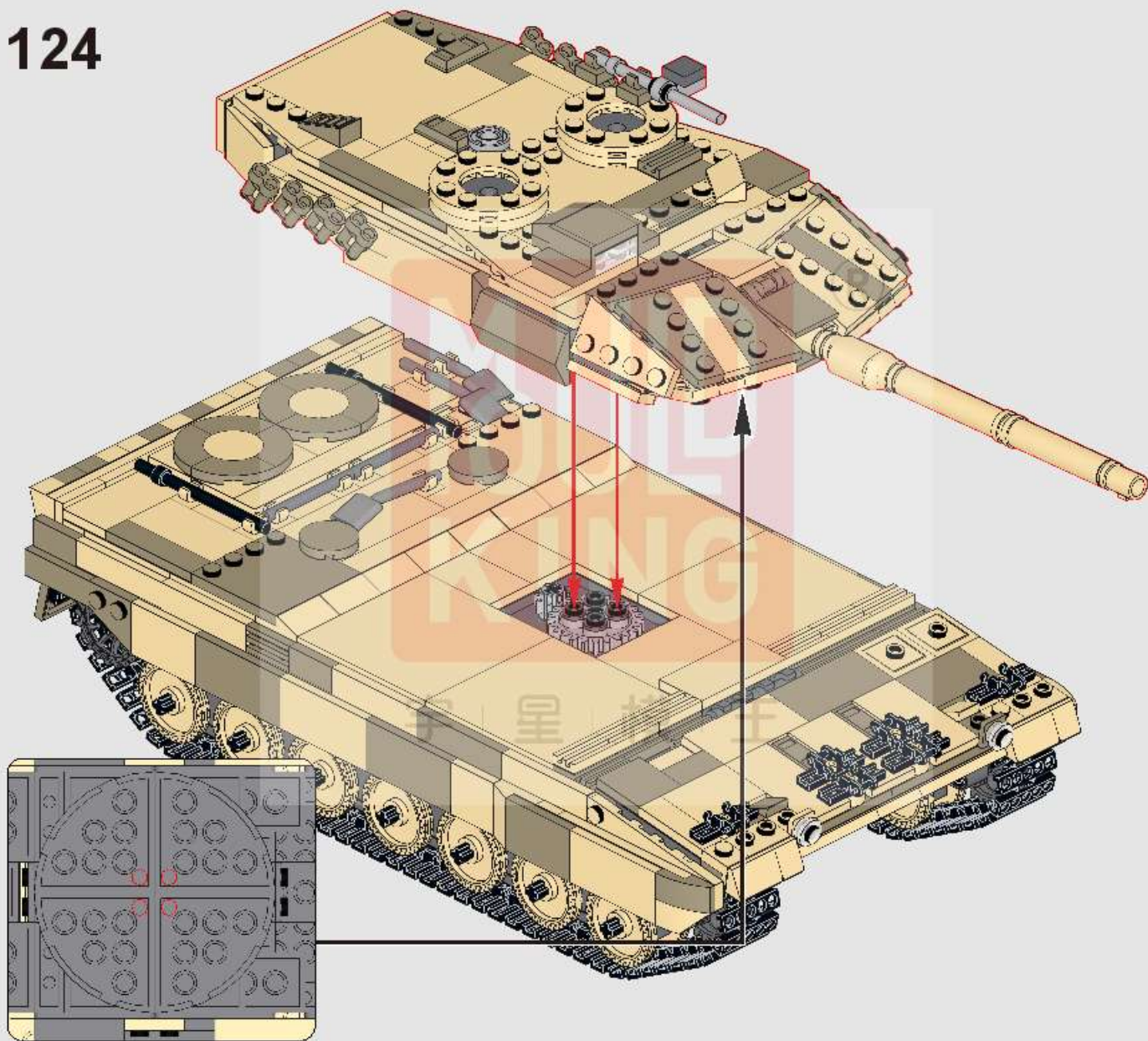

125

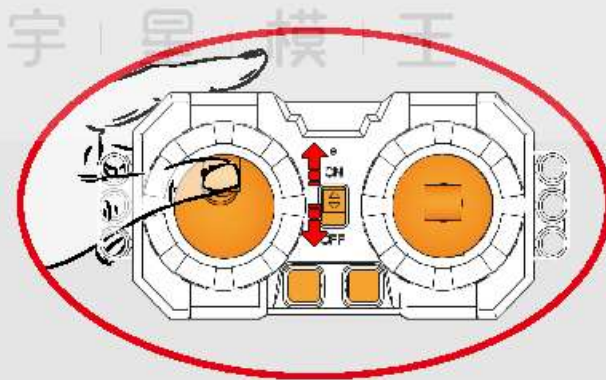

126

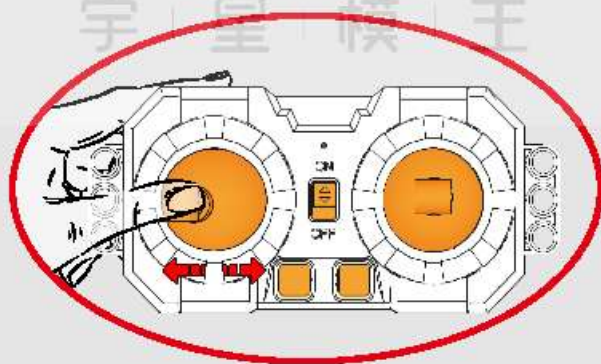
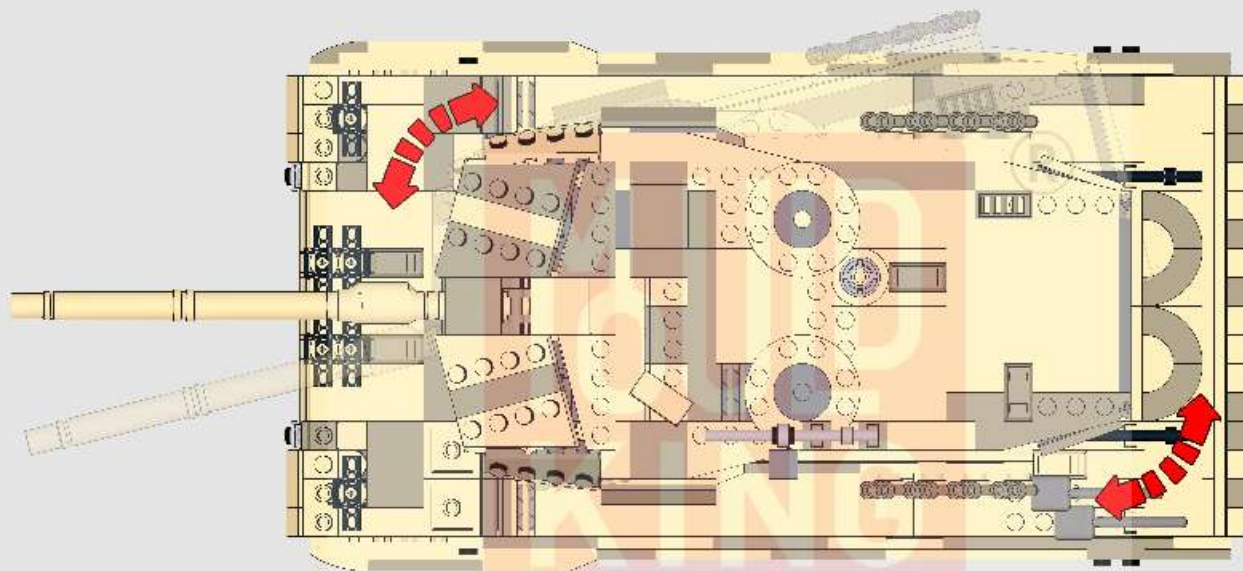

127

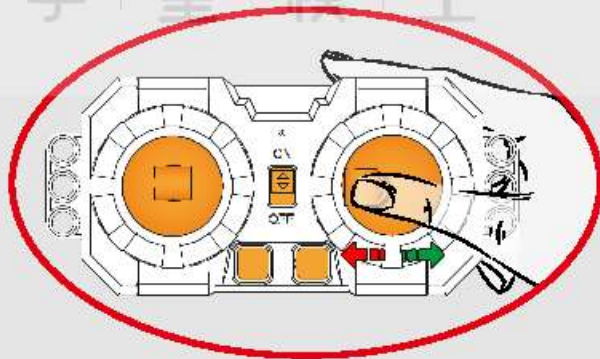
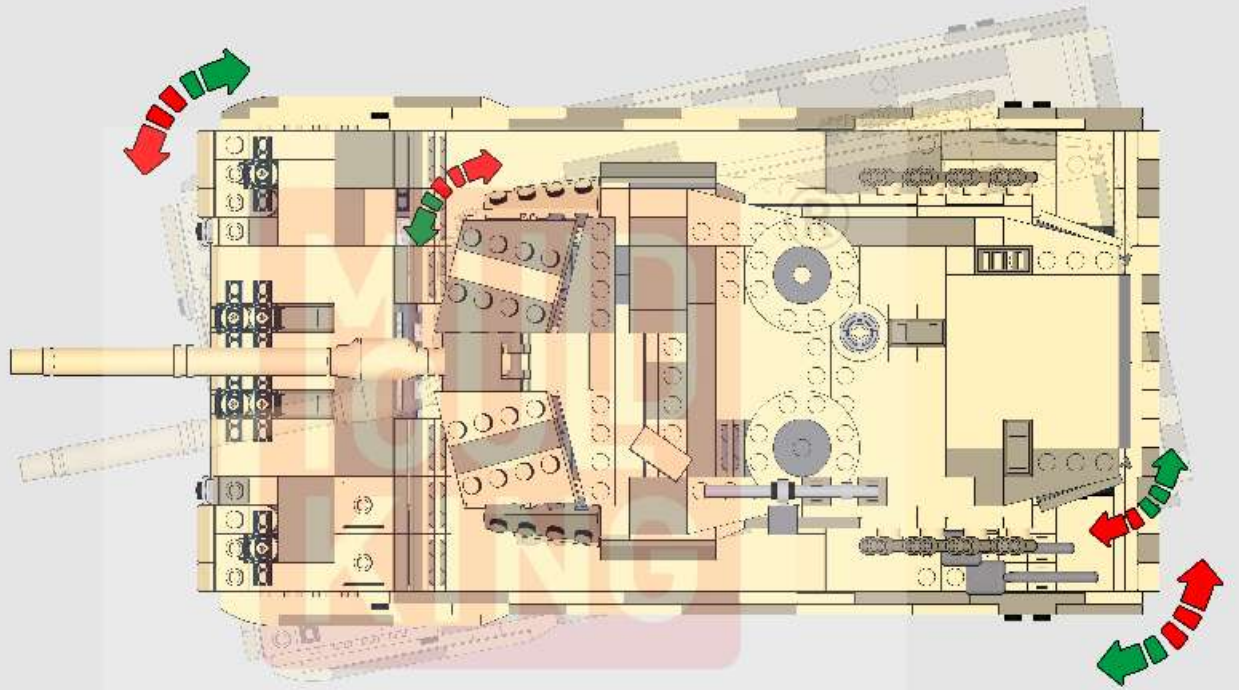

128

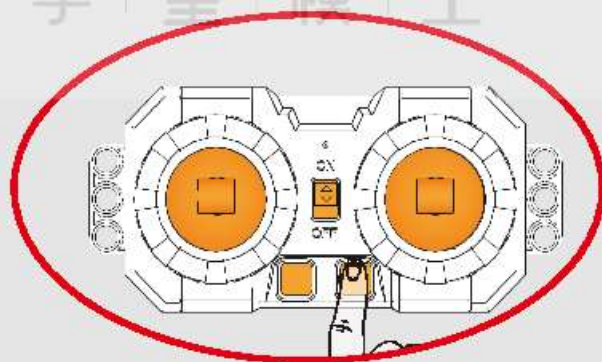
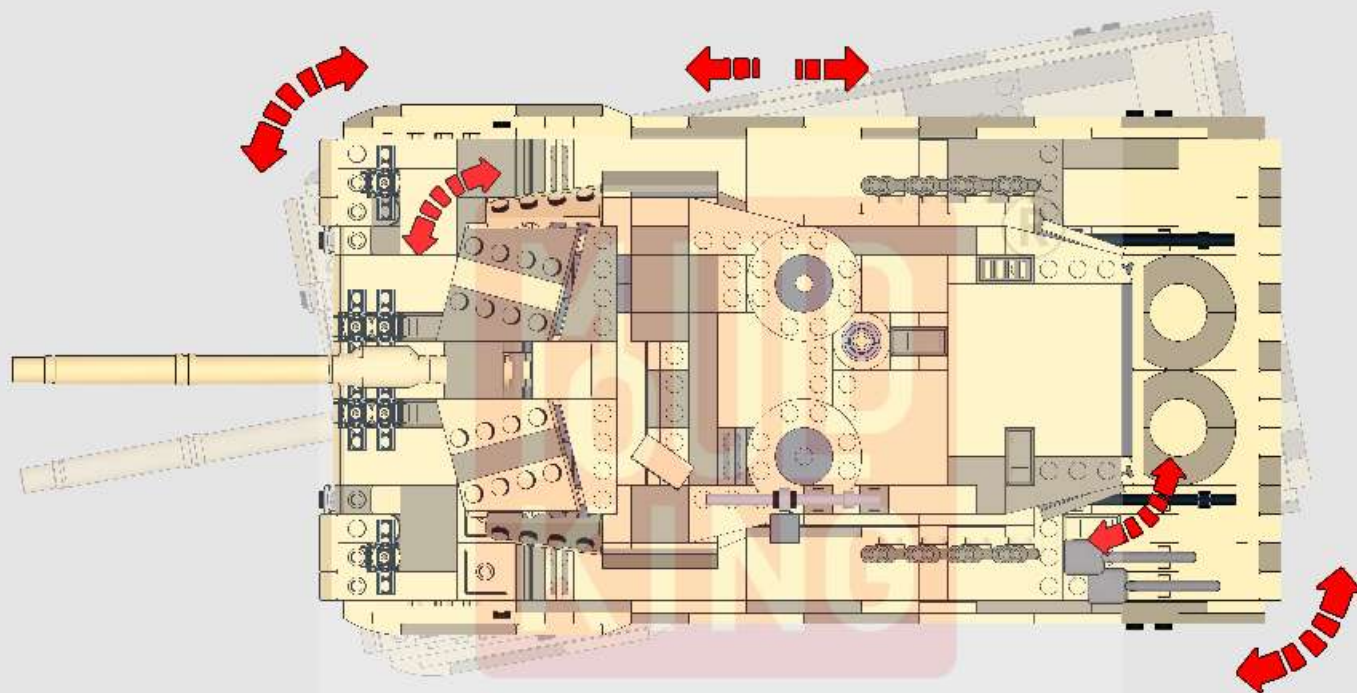

129

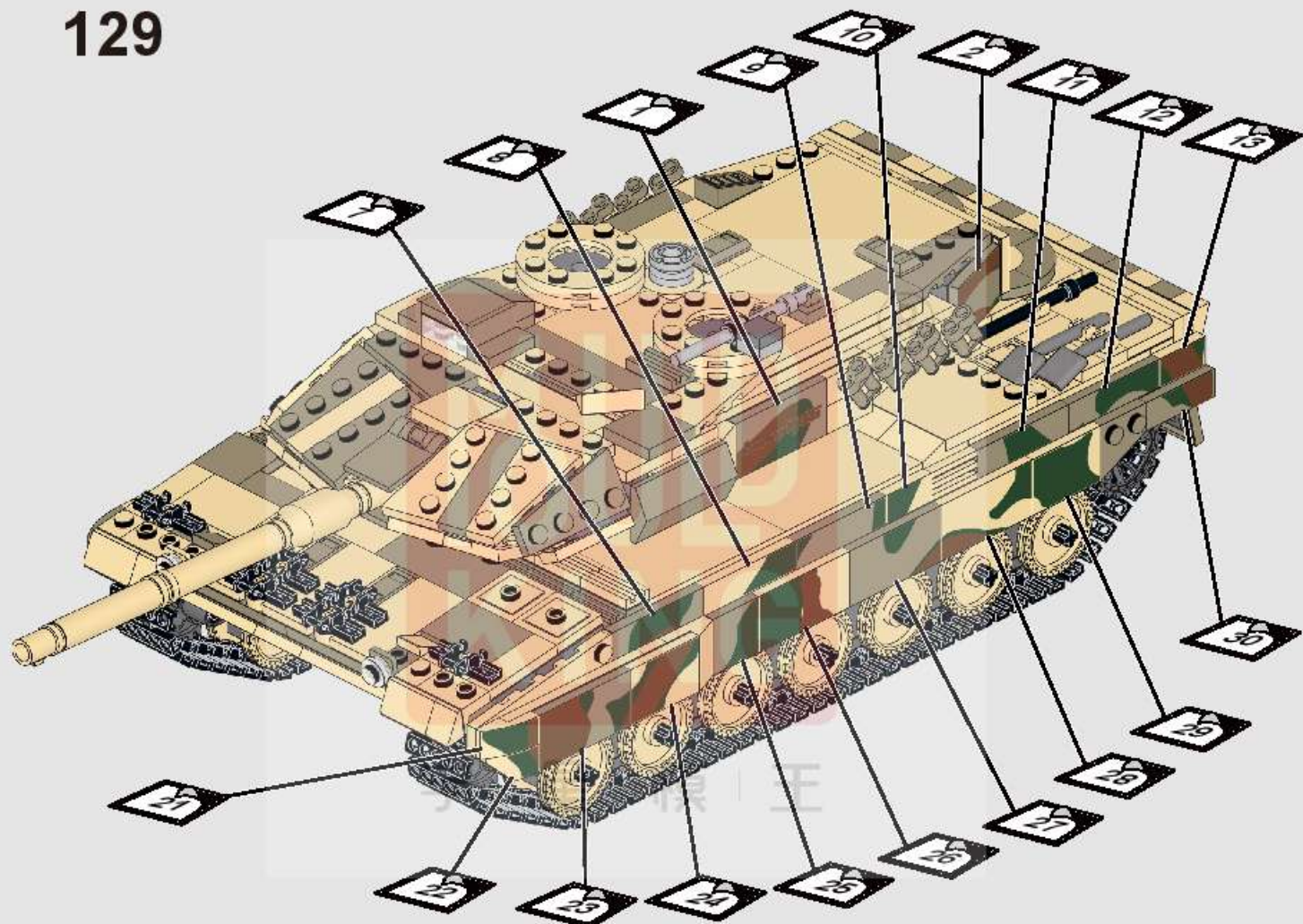

此贴纸为热感压标贴纸，不可重复粘贴

This sticker is a thermal pressure label sticker and cannot be pasted repeatedly

贴纸使用方法：撕起贴纸，对准位置随后均匀刮动，撕掉透明膜即可。

How to use the sticker: Tear off the sticker, align the position and then scrape it evenly, tear off the transparent film.

130

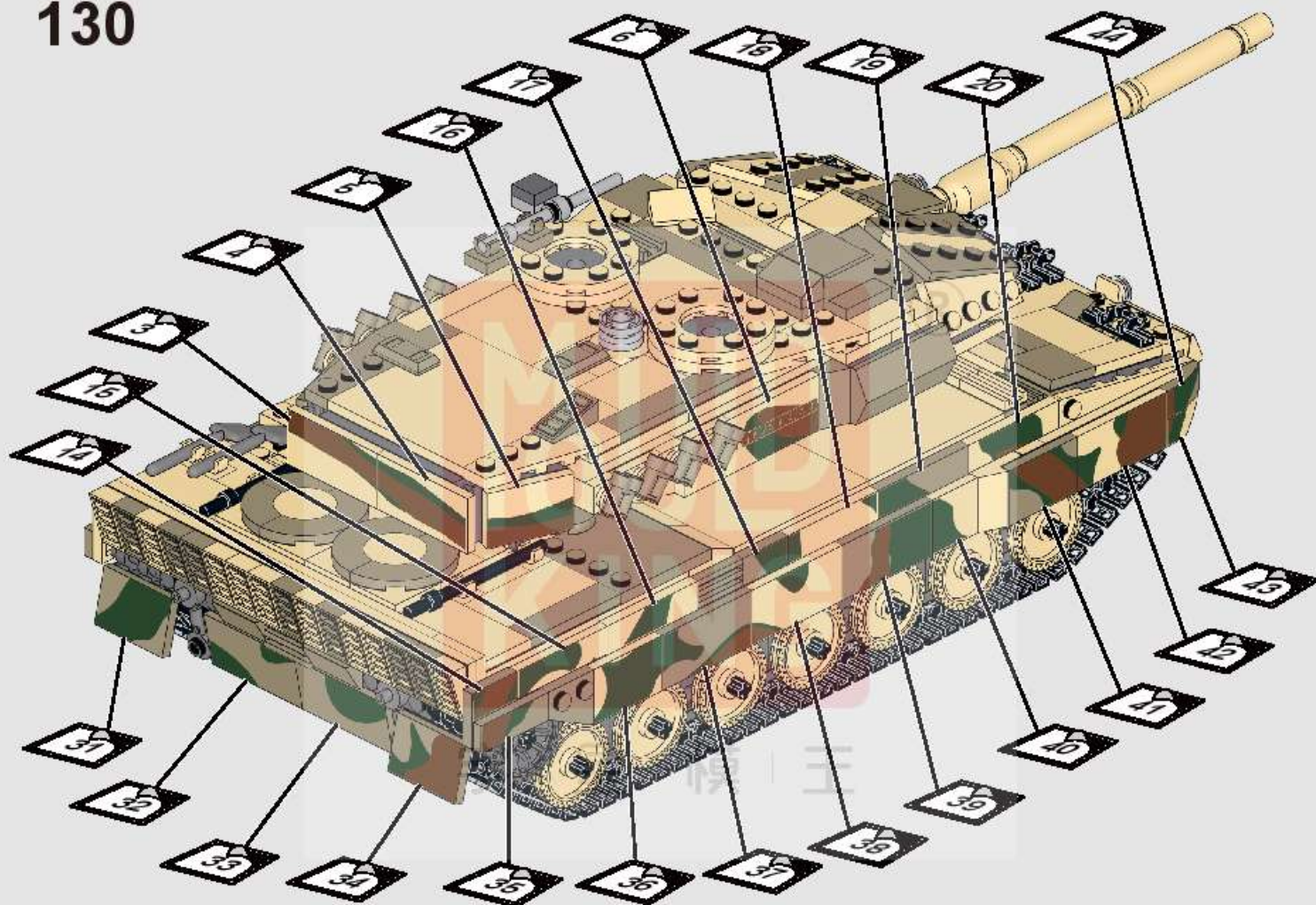

此贴纸为热感压标贴纸，不可重复粘贴

This sticker is a thermal pressure label sticker and cannot be pasted repeatedly

贴纸使用方法：撕起贴纸，对准位置随后均匀刮动，撕掉透明膜即可。

How to use the sticker: Tear off the sticker, align the position and then scrape it evenly, tear off the transparent film.

